

7800 SERIES S7800A Keyboard Display Module

PRODUCT DATA

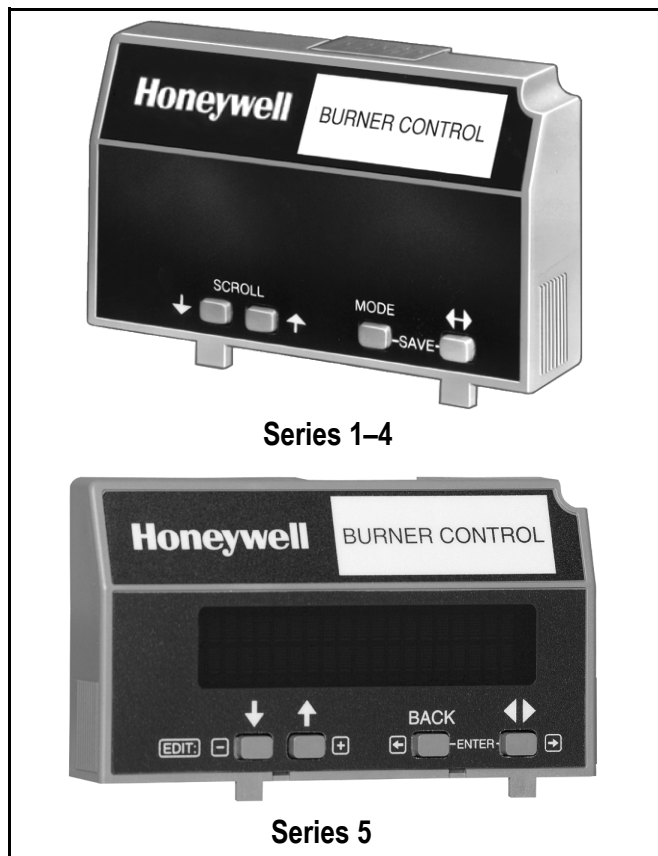

Series 1-4

Series 5

The KDM provides local or remote annunciation of operation and fault information, remote reset, report generation, burner control data and diagnostic information. The KDM is part of the 7800 SERIES of microprocessor-based burner controls for gas, oil, coal or combination fuel single burner applications.

The 7800 SERIES is programmed to provide a level of safety, functional capabilities and features beyond the capacity of conventional controls.

The S7800A1001 KDM Series 5 offers the following technical advancements to the 7800 SERIES devices:

- Compatible with installed Honeywell 7800 SERIES systems.
- A three screen two-row by twenty-column readout set of "Call Service" (Business Card) alpha/numeric directions can be displayed instead of the standard lockout display message. (Pass Code protected feature). This "business card" can be cloned to other displays to save setup time.
- Enable ModBus Communication feature.

The Business Card (Call Service) can be made up using:

- Capital letters (A through Z).
- Lower case letters (a through z).
- Numbers (1 through 0).
- Symbols (!, @, #, \$, %, etc.).
- Spanish symbols.

Programming can be done with the S7800 KDM mounted on a 7800 SERIES Relay Module or with a 13 Vdc power source connected to the KDM through the 203541 5-wire connector.

Since your Business Card (Call Service) S7800A1001 will be left at the job site, programming your personal three-number password and personal lockout message can be set up ahead of time without being connected to a 7800 SERIES device. A clone function allows you to make multiple Business Cards from the original display.

APPLICATION

The S7800A Keyboard Display Module (KDM) provides current system status along with first-out annunciation and system diagnosis using a two-row by twenty-column readout.

Contents

Application	1
Features	2
Specifications	2
Ordering Information	2
Installation	3
Wiring	4
Troubleshooting	12

Contents

Hold and Fault Message Summary	16
Appendix A: Display Setup	25
Display Setup—CLONE	25
Display Setup—CS ON/OFF	28
Display Setup—CS EDIT	30
Appendix B: Edit Text and Characters	32
Appendix C: ModBus Data Features	33



FEATURES

- **Application flexibility.**
- **Communication interface capability.**
 - Through Q7700 Network Interface Unit
 - Through 203541 Connector on the ModBus data highway.
- **Dependable, long-term operation provided by microcomputer technology.**
- **First-out annunciation and system diagnostics provided by a 2-row by 20-column display.**
- **First-out expanded annunciation with 24 limit and interlock Light Emitting Diodes (LEDs).**
- **Local or remote annunciation of operation and fault information.**
- **UL NEMA Class 4 rating when p/n 204718A,C NEMA 4 cover is used.**
- **Remote reset.**
- **Report generation.**
- **Burner controller data:**
 - **Sequence status.**
 - **Sequence time.**
 - **Hold status.**
 - **Lockout/alarm status.**
 - **Flame signal strength.**
 - **Expanded annunciator status.**
 - **Total cycles of operation.**
 - **Total hours of operation.**
 - **Fault history of six most recent faults:**
 - **Cycles of operation at time of fault.**
 - **Expanded annunciator data at time of fault.**
 - **Fault message and code.**
 - **Hours of operation at time of fault.**
 - **Sequence status at time of fault.**
 - **Sequence time at time of fault.**
 - **Diagnostic information:**
 - **Device type.**
 - **Flame amplifier type.**
 - **Flame failure response time (FFRT).**
 - **Manufacturing code.**
 - **On-Off status of all digital inputs and outputs.**
 - **PREPURGE time selected.**
 - **Software revision and version of 7800 SERIES.**
 - **Relay Module and KDM.**
 - **Status of configuration jumpers.**
 - **Status of Run/Test Switch.**

SPECIFICATIONS

Electrical Ratings:

Voltage and Frequency: 13 Vdc peak full wave rectified (+20%/-15%).

Power Dissipation: 7W maximum.
VA consumption: 2 VA maximum.

Terminal Ratings:

Power: 13 Vdc peak full wave rectified.
Earth Ground.

Environmental Ratings:

Ambient Temperature Ranges:

Operating: -40°F (-40°C) to +140°F (+60°C).

Storage: -60°F (-51°C) to +150°F (+66°C).

Humidity: 85% relative humidity continuous, noncondensing.

NOTE: UL NEMA Class 4 rating when P/N 204718A,C NEMA 4 Cover is used.

Vibration: 0.5G environment.

Mechanical:

Dimensions: See Fig. 1.

Weight: 4 oz. (124 grams), unpacked.

Display:

40 character (2 rows by 20 columns).

Languages:

S7800A1001 English Language display.

Approvals:

Underwriters Laboratories Inc. Listed: File No. MP268, guide No. MCCZ.

Canadian Standards Association Certified: No. LR9S329-3.

Factory Mutual Approved: Report No. J.I.1V9A0.AF.

IRI: Acceptable.

Federal Communications Commission: Part 15, Class B emissions.

EN60730: For compliance with remote KDM mounting requirements, provide electrical insulation separation by insulation using double or reinforced insulation. Do this by: Optically isolating the communication or remote reset lines from the control cabinet, or provide physical separation from the communication or remote display cover assembly (part number 204718A) or other suitable enclosure that meets the IP40 class of protection.

Accessories:

203541 ControlBus™ 5-wire Electrical Connector.

S7810A1009 Data ControlBus™ Module.

203765 Remote Display Mounting Bracket.

221818A 60 in. (1.5 m) Extension Cable Assembly.

221818C 120 in. (3 m) Extension Cable Assembly.

204718A NEMA 4 Cover Assembly for S7800A KDM.

204718B NEMA 1 Cover Assembly for S7800A KDM.

204718C NEMA 4 Cover Assembly for S7800A KDM with reset button.

205321B Remote Display Flush Mount Kit.

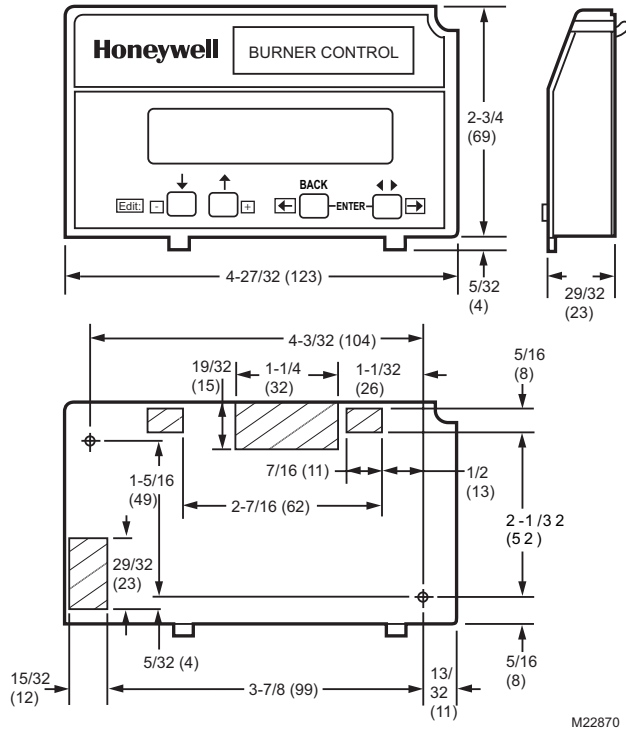

M22870

Fig. 1. Approximate dimensions of S7800A1001 in. (mm).

INSTALLATION

⚠ WARNING

Electrical Shock Hazard.

Can cause severe injury, death or property damage.

Disconnect the power supply before beginning installation to prevent electrical shock and equipment damage. More than one power supply disconnect can be involved.

When Installing This Product...

1. Read these instructions carefully. Failure to follow them could damage the product or cause a hazardous condition.
2. Check the ratings given in the instructions and marked on the product to make sure the product is suitable for your application.

3. Installer must be a trained, experienced, flame safeguard service technician.
4. After installation is complete, check out the product operation as provided in these instructions.
5. Be sure wiring complies with all applicable codes, ordinances and regulations.
6. See Fig. 5, 6 and 7 for S7800A unique wiring connections.

IMPORTANT

1. This equipment generates, uses and can radiate radio frequency energy and, if not installed and used in accordance with the instructions, can cause interference to radio communications. It has been tested and found to comply with the limits for a Class B computing device of Part 15 of FCC rules which are designed to provide reasonable protection against such interference when operated in a commercial environment. Operation of this equipment in a residential area can cause interference, in which case, users, at their own expense, can be required to take whatever measures are required to correct this interference.
2. This digital apparatus does not exceed the Class B limits for radio noise for digital apparatus set out in the Radio Interference Regulations of the Canadian Department of Communications.

Humidity

Install the S7800A where the relative humidity never reaches the saturation point. The S7800 is designed to operate in a maximum 85% RH continuous, noncondensing, moisture environment.

Vibration

Do not install the S7800A where it can be subjected to vibration in excess of 0.5G continuous maximum vibration.

Weather

The S7800A is not designed to be weather tight. If installed outdoors, the S7800A must be protected by an approved weather-tight enclosure such as the 204718A or 204718C NEMA 4 Enclosure listed in Accessories.

S7800A1001 Series 5 Embedded Features

A. See Appendix A to set up the embedded features:

SERVICE NOTE:

The S7800A1001 can either do the Expanded Annunciator Feature or ModBus -- not both. If BOTH are required, order the S7810M1003 ModBus Module for the ModBus option.

Mounting KDM on 7800 SERIES Relay Module.

1. Align the two interlocking ears of the KDM with the two mating slots on the 7800 SERIES Relay Module. See Fig. 2.



Fig. 2. Keyboard Display Module mounting.

2. Insert the two interlocking ears into the two mating slots and, with a hinge action, push on the lower corners of the KDM to secure it to the 7800 SERIES Relay Module.
3. Make sure the KDM is firmly in place.

Remote Mounting KDM

The KDM can be mounted either on the face of a panel door or on other remote locations. See Fig. 3. When mounting the KDM on the face of a door panel, closely follow these instructions:

Door Panel Mounting



Fig. 3. Panel mounting of a Keyboard Display Module.

1. Select the location on the door panel for flush mounting.
2. Pay attention to the insertion dimensions of the two KDM screws, two interlocking ears, and the two plug-in connections to allow for sufficient clearance.
3. Use the KDM or Data ControlBus Module™ as a template (Fig. 19) and mark the two screw locations, interlocking ear locations and the two plug-in connector locations.

4. Drill the pilot holes for the mounting screws.
5. Cut holes in the door panel for the interlocking ears and the two plug-in connectors.
6. Mount the KDM, securing it with the two screws provided in the KDM bag assembly.

Remote Display Mounting Bracket

Use the 203765 Remote Display Mounting Bracket when mounting the KDM on a wall or remote location:

1. Use the 203765 Remote Display Mounting Bracket as a template to mark the four screw locations.
2. Drill the pilot holes for the four mounting screws.
3. Mount the 203765 Remote Display Mounting Bracket by securing the four no. 6 screws (M3.5 x 0.6). See Fig. 4.
4. Mount the KDM by aligning the two interlocking ears with the two mating slots on the remote mounting bracket.
5. Insert the two interlocking ears into the two mating slots.
6. Push on the lower corners of the KDM to secure it to the remote mounting bracket.
7. Make sure the KDM is firmly in place.

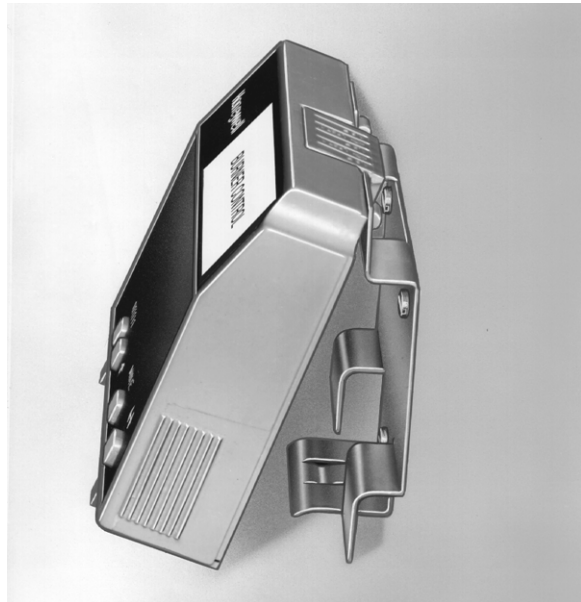

Fig. 4. Remote mounting of a Keyboard Display Module using a 203765 Remote Display Mounting Bracket.

WIRING

⚠ WARNING

Electrical Shock Hazard.

Can cause severe injury or death.

To prevent electrical shock and equipment damage, disconnect the power supply from the main disconnect before beginning installation. More than one disconnect can be involved.

1. Refer to Fig. 5, 6, and 7 for proper wiring.
2. Make sure all wiring complies with all applicable electrical codes, ordinances and regulations.
3. For recommended wire size and type, see Table 1.

4. For Recommended grounding practices, see Table 2.
5. For KDM: The KDM is powered from a low voltage, energy-limited source. It can be mounted outside of a control panel if it is protected from mechanical damage.

NOTE: A 13 Vdc power supply must be used any time more than one KDM is used. A maximum of two KDM, Data ControlBus™ Modules or S7810B Multi-Drop Switch Modules are allowed in any combination.

Table 1. Recommended Wire Size and Part Number.

Application	Recommended Wire Size	Recommended Part Number
Keyboard Display Module	22 AWG two-wire twisted pair with ground, or five-wire.	Belden 8723 shielded cable or equivalent.
Data ControlBus™ Module	22 AWG two-wire twisted pair with ground, or five-wire.	Belden 8723 shielded cable or equivalent.
Remote Reset Module	22 AWG two-wire twisted pair, insulated for low voltage.	—
Communications Interface ControlBus Module™	22 AWG two-wire twisted pair with ground.	Belden 8723 shielded cable or equivalent.
13 Vdc full wave rectified transformer power input.	18 AWG wire, insulated for voltages and temperatures for given applications.	TTW60C, THW75C, THHN90C

Table 2. Recommended Grounding Practices.

Ground Type	Recommended Practice
Signal ground (KDM, Data ControlBus™ Module, Communications Interface ControlBus Module™).	Use the shield of the signal wire to ground the device to the signal ground terminals [3(c)] of each device. Connect the shield at both ends of the daisy chain to ground.

6. Recommended wire routing:
 - a. ControlBus:
 - (1) Do not route the ControlBus cable in conduits that carry line voltage circuits.
 - (2) Avoid routing the ControlBus cable close to ignition transformer leadwires.
 - (3) Route the ControlBus cable outside of conduit if properly supported and protected from damage.
 - b. Remote Reset:
 - (1) Do not run high voltage ignition transformer wires in the same conduit with the Remote Reset wiring.
 - (2) Do not route Remote Reset wires in conduit with line voltage circuits.
7. Maximum wire lengths:
 - a. KDM: The maximum length interconnecting wire is 4000 ft (1219m).
 - b. Remote Reset leadwires: The maximum length wire is 1000 ft (300m) to a Remote Reset push-button.
8. Install all electrical connectors.
9. Restore power to the panel.

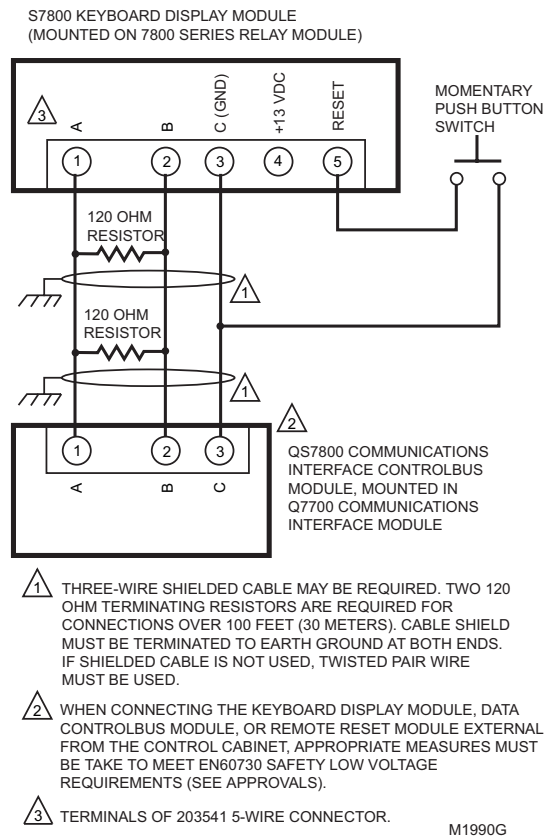
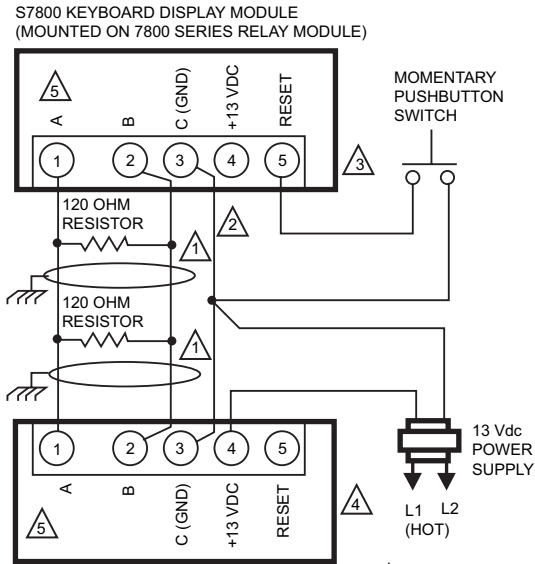

Fig. 5. Wiring the Keyboard Display Module.



- S7800 REMOTE KEYBOARD DISPLAY MODULE ²
- ¹ THREE WIRE SHIELDED CABLE MAY BE REQUIRED. TWO 120 OHM TERMINATING RESISTORS ARE REQUIRED FOR CONNECTING OVER 100 FEET [30 METERS]. CABLE SHIELD MUST BE TERMINATED TO EARTH GROUND AT BOTH ENDS. IF SHIELDED CABLE IS NOT USED, TWISTED PAIR WIRE MUST BE USED.
 - ² WHEN CONNECTING THE KEYBOARD DISPLAY MODULE DATA CONTROLBUS MODULE[®], OR REMOTE RESET MODULE EXTERNAL FROM THE CONTROL CABINET, APPROPRIATE MEASURES MUST BE TAKEN TO MEET EN60730 SAFETY LOW VOLTAGE REQUIREMENTS (SEE APPROVALS).
 - ³ 7800 SERIES RELAY MODULE CAN SUPPORT ONE S7800 KEYBOARD DISPLAY MODULE. A 13 Vdc POWER SUPPLY IS REQUIRED FOR EACH ADDITIONAL DISPLAY.
 - ⁴ UP TO 36 S7800 KEYBOARD DISPLAYS CAN BE CONNECTED TO A SINGLE 7800 RELAY MODULE NOT TO EXCEED 4000 FEET (1219M) TOTAL LEADWIRE RUN. DAISY CHAIN 1 TO 1, 2 TO 2, 3 TO 3 AND PROVIDE 13 Vdc POWER SUPPLY FOR EACH S7800 DISPLAY.
 - ⁵ TERMINALS OF 203541 5-WIRE CONNECTOR. M5006G

Fig. 6. Wiring for multiple Keyboard Display Modules.

KDM Display

The first line of the KDM display provides current status of the burner sequence (STANDBY, PURGE, PILOT IGN, MAIN IGN, RUN and POSTPURGE), timing information (PURGE, PILOT IGN, MAIN IGN and POSTPURGE) in minutes and seconds, hold information (PURGE HOLD), and lockout information (Lockout, Fault Code, Message and Sequence). The extreme right side of the first line will be either blank or will show a small arrow pointing to the second line followed by a two-letter code (DI—Diagnostic Information, Hn—Fault History Information (where n equals the number of the fault), and EA—Expanded

Annunciator). When the arrow and two-letter code are displayed, it indicates the second line is showing a selectable message submenu. The second line will display selectable or preemptive messages. A selectable message supplies information for flame strength, system status indication, system or self-diagnostics and troubleshooting. A preemptive message has parentheses around the message and supplies a detailed message to support the sequence status information. A preemptive message can also be a lockout message. A preemptive message replaces a selectable message to support the sequence status information. It also replaces a selectable message after 60 seconds if it or a lockout message is available. The 7800 SERIES Relay Module LED provide positive visual indication of the Relay Module sequence. The LED is energized simultaneously with the correct sequence description.

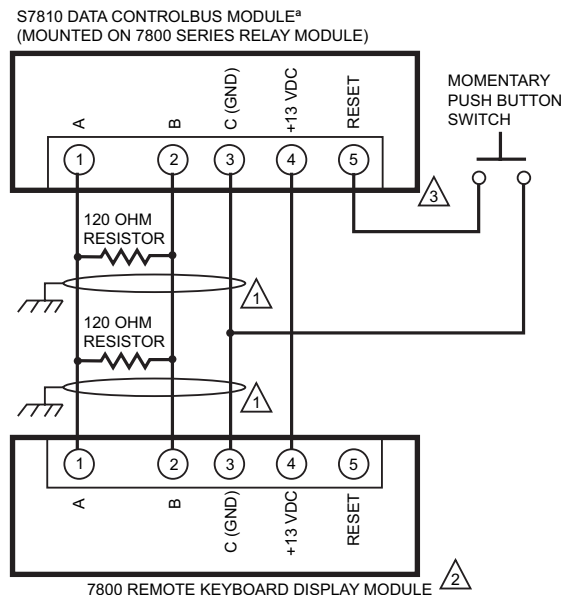

- S7810 DATA CONTROLBUS MODULE[®] (MOUNTED ON 7800 SERIES RELAY MODULE)
- 7800 REMOTE KEYBOARD DISPLAY MODULE ²
- ¹ THREE WIRE SHIELDED CABLE MAY BE REQUIRED. TWO 120 OHM TERMINATING RESISTORS ARE REQUIRED FOR CONNECTIONS OVER 100 FEET. CABLE SHIELD MUST BE TERMINATED TO EARTH GROUND AT BOTH ENDS. IF SHIELDED CABLE IS NOT USED, TWISTED PAIR WIRE MUST BE USED.
 - ² WHEN CONNECTING THE KEYBOARD DISPLAY MODULE DATA CONTROLBUS MODULE[®], OR REMOTE RESET MODULE EXTERNAL FROM THE CONTROL CABINET, APPROPRIATE MEASURES MUST BE TAKEN TO MEET EN60730 SAFETY LOW VOLTAGE REQUIREMENTS (SEE APPROVALS).
 - ³ 221818A OR C EXTENSION CAN BE USED IN PLACE OF THE S7810 DATA CONTROLBUS MODULE[®] IF DISPLAY IS TO A CABINET DOOR. M5285C

Fig. 7. Wiring Keyboard Display Module for remote mounting.

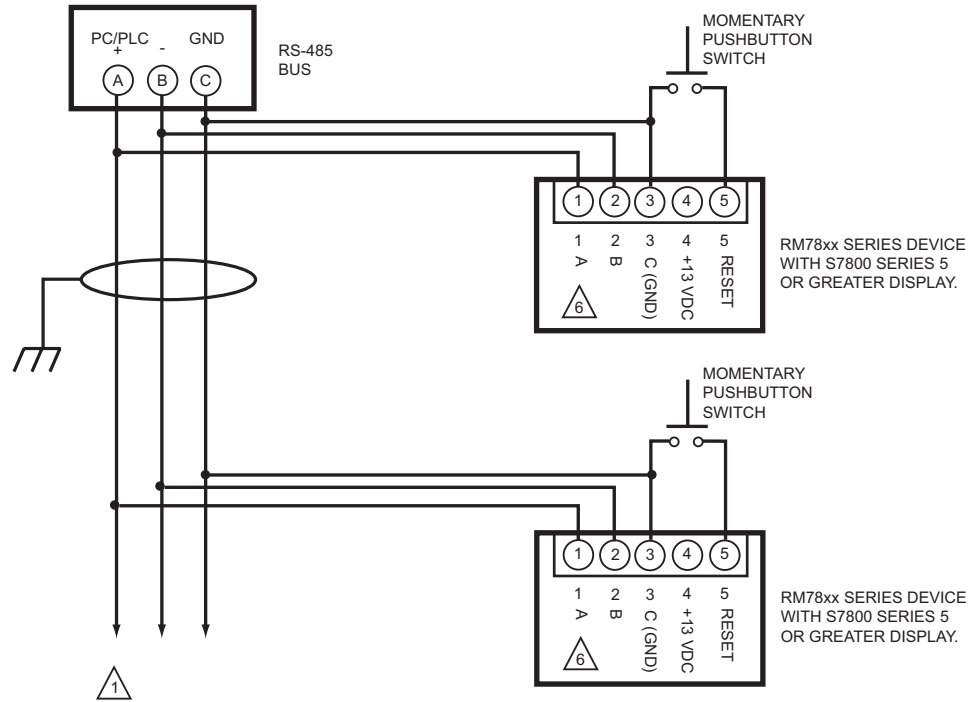

- 1 MULTI-DROP RS-485 COMMUNICATION BUS. UP TO 31 S7800 SERIES 5 OR GREATER DISPLAYS CAN BE CONNECTED TO A SINGLE BUS WITHOUT AN RS-485 REPEATER. UP TO 99 MODBUS™ (SUBNETWORKS) CAN BE CONNECTED TO A BUS WITH RS-485 REPEATERS. WHEN USING AN RS-485 REPEATER, THE REPEATER MUST BE INSTALLED EVERY 30TH MODULE.
- 2 THE SUBNETWORKS MUST BE WIRED IN A DAISY CHAIN CONFIGURATION. RECOMMEND THAT THE PC/PLC BE AT ONE END OF THE DAISY CHAIN.
- 3 MODBUS™ COMMUNICATION BUS TERMINATION RESISTORS:
 - A. WITHOUT RS-485 REPEATER:
 MODULES AT THE CLOSEST AND FARTHEST END OF THE DAISY CHAIN REQUIRE TERMINATION RESISTORS. INSTALL A 120 OHM, 1/4 WATT RESISTOR BETWEEN TERMINALS A AND B OF THE PC/PLC (IF INSTALLED AT ONE END THE DAISY CHAIN). INSTALL A 120 OHM, 1/4 WATT RESISTOR BETWEEN TERMINALS 7 AND 8 OF THE LAST S7810M MODBUS™ MODULE IN THE DAISY CHAIN.
 - B. WITH RS-485 REPEATER:
 WHEN AN RS-485 REATER IS USED, TWO DAISY CHAIN CONFIGURATIONS ARE EFFECTIVELY FORMED. MODULES AT THE CLOSEST AND FARTHEST ENDS OF EACH DAISY CHAIN REQUIRE TERMINATION RESISTORS. INSTALL A 120 OHM, 1/4 WATT RESISTOR BETWEEN TERMINALS A AND B OF THE PC/PLC (IF INSTALLED AT THE END OF THE DAISY CHAIN). INSTALL A 120 OHM, 1/4 WATT RESISTOR BETWEEN INPUT TERMINALS DATA+ AND DATA- OF THE RS-485 REPEATER. INSTALL A 120 OHM, 1/4 WATT RESISTOR BETWEEN TERMINALS 7 AND 8 OF THE LAST S7810M MODBUS™ MODULE IN THE ADDITIONAL DAISY CHAIN.
- 4 LOCAL RS-485 COMMUNICATIONS BUS. THE DEVICES ON THIS BUS MUST BE WIRED IN A DAISY CHAIN CONFIGURATION. THE ORDER OF INTERCONNECTION IS NOT IMPORTANT. THE MODULES ON THE CLOSEST AND FARTHEST ENDS OF THE DAISY CHAIN REQUIRE A 120 OHM, 1/4 WATT TERMINATION RESISTOR BETWEEN TERMINALS 1 AND 2 OR A AND B.
- 5 THREE WIRE SHIELDED CABLE (BELDEN 8723 SHIELDED OR EQUIVALENT) IS RECOMMENDED AND SHOULD BE GROUNDED AS FOLLOWS: IF NO INTERFERENCE IS PRESENT, OR TO REDUCE CAPACITIVE INTERFERENCE, THE SHIELD SHOULD BE GROUNDED AT ONE END. WHEN GROUNDING ONLY ONE END OF THE THE SHIELD, THE SHIELD END CLOSEST TO THE S7810M MODBUS™ MODULE SHOULD BE ATTACHED TO EARTH GROUND. TO REDUCE INDUCTIVE INTERFERENCE (RF INTERFERENCE), THE SHIELD SHOULD BE GROUNDED AT BOTH ENDS.
- 6 TERMINAL NUMBERS ARE ON 203541 5-WIRE CONNECTOR (SUPPLIED WITH REMOTE MOUNTING BRACKET).

M24190

Fig. 8. Wiring for ModBus™ Feature.

NOTE: LED has been replaced by block characters visible on the MB address setup menu.

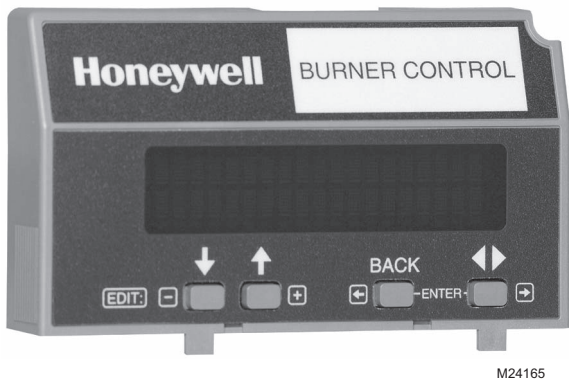

Fig. 9. S7800 Keyboard Display Module.

Keyboard Functions

The keyboard contains four push-buttons with separate functions (SCROLL-down, SCROLL-up, MODE, and CHANGE-LEVEL). The MODE and CHANGE-LEVEL, when pressed together, provide a SAVE function. When in the Setup Screen—Mode and Change Level serves as Menu or Enter.

1. Down-up arrow push-buttons. See Fig. 10. The down-up arrow push-buttons are used to scroll through the selectable messages. The double-headed arrow (\updownarrow), which is located in the lower left position of the second line of the display, represents the down-up push-buttons. The down-up push-buttons can be pressed to display the selectable messages one at a time or held down to scroll through the selectable messages at the rate of two per second. When the last item of the selectable message is viewed, the display wraps around and displays the first selectable message again.
2. The $\leftarrow\rightarrow$ push-button, see Fig. 11. The $\leftarrow\rightarrow$ push-button is used to change between the first hierarchy of selectable messages to a subset of selectable messages. The $\leftarrow\rightarrow$ push-button can also be used to change from a subset message to a first level selectable message. The symbol located on the second line in the lower right corner of the display, represents a subset of selectable messages.
3. BACK push-button, see Fig. 12. Use the BACK push-button to instantaneously switch the display from a second-line selectable message to a second-line preempted message. The sixty second time-out function can also be used for this task. The BACK push-button only works if there is a second-line preempted message or a lockout message.

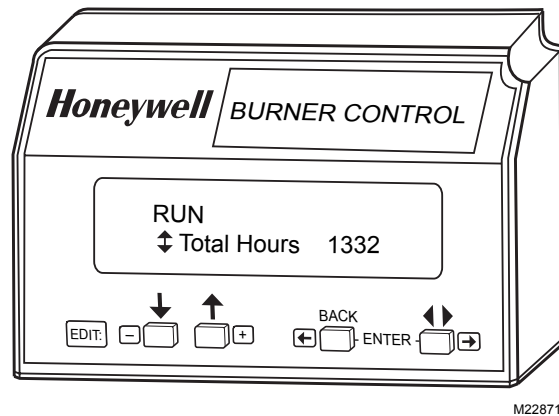
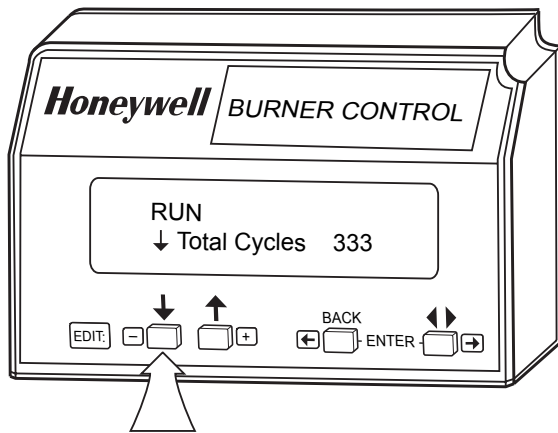

Fig. 10. \updownarrow Push-button function.

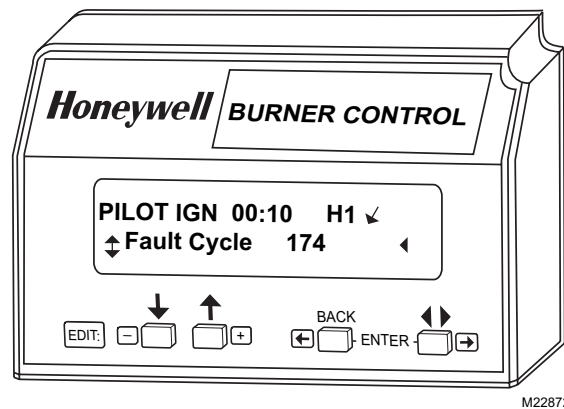
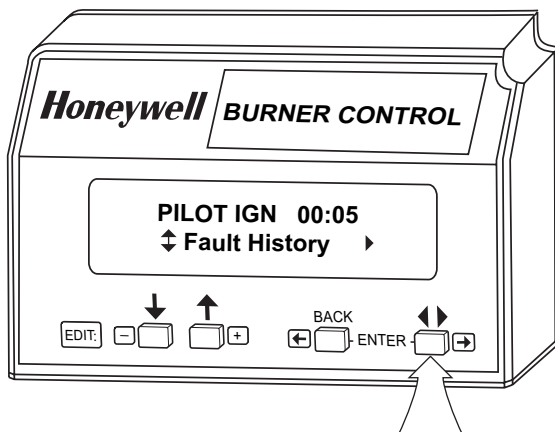

Fig. 11. $\leftarrow\rightarrow$ push-button function.

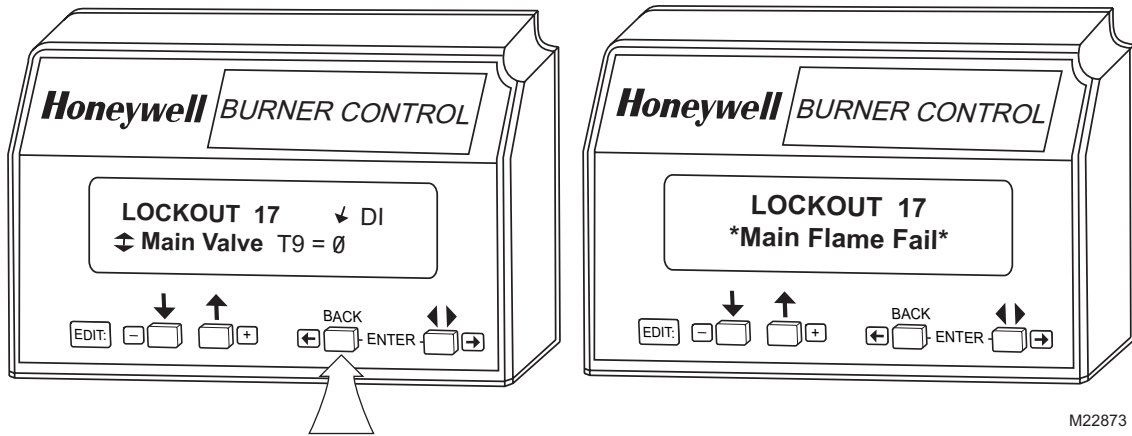

Fig. 12. BACK push-button function.

4. SAVE function, see Fig. 13, 14, and 15.
 - a. Enables users to identify the selectable 2nd line message they want to view upon power restoration. (See "Total Cycles" instead of "Flame Signal" for example.) The second line selectable message is restored to the most recently saved selection when power returns.
 - b. Press the down-up arrows until the desired second line is displayed. Press the ENTER function. (See Fig. 13.)

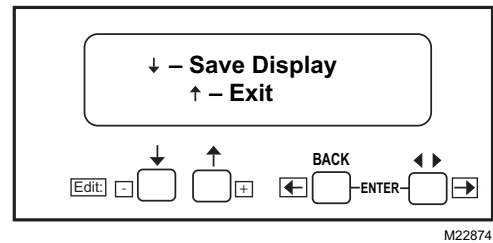

Fig. 14. Save Display/Exit screen

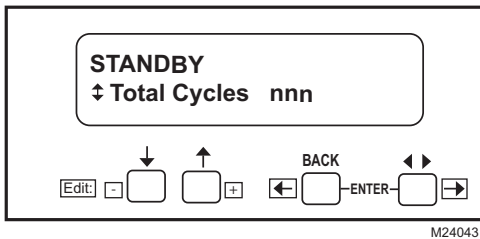

Fig. 13. SAVE function.

- c. The following Display will appear:

- d. Press the ↓ to save the desired second line. Pressing the ↑ will EXIT without changing the second line.



Fig. 15. Save Display...Saving screen.

The second line of the display is now changed to the new selected message.

Table 3. Selectable Messages.

Selectable Message/Display	Description	Possible States/ Range (Terminals)	Comments
↕Flame Signal	Flame signal strength.	0 - 5.0 Vdc Flame Amp (+ and - (Com))	Flame relay pull-in and drop-out value 1.25 Vdc.
↕Total Cycles	Total number of equipment operating cycles.	0 - 99,999 (250,000; 999,999 ^c) cycles ^a	Cycle will be updated each time main valve is energized.
↕Total Hours	Total number of equipment operating hours.	0 - 99,999 (250,000; 999,999 ^c) hours ^a	Hour will be updated each time main valve output is energized for 60 minutes.
↕Fault History > (Six most recent faults)	First level prompt for history information. Has subset level.	—	—
↕Fault Cycle H1	Cycle when fault occurred.	0 - 99,999 cycles (250,000; 999,999 ^c) cycles	—
↕Fault Hours H1	Run hour when fault occurred.	0 - 99,999 (250,000; 999,999 ^c) hours ^a	—
↕Fault Code H1	Number that identifies the reason for lockout.	0 - 999	—
↕*Fault Message* H1	Indicates cause of lockout.	—	—
↕Sequence Message H1	Indicates where in the sequence the lockout occurred.	—	—
↕(Second Line Message) H1	Second line message explains any further information that is available from the 7800 SERIES or may be blank if there is not a preemptive second-line. H2...H6 etc.	—	—
↕Diagnostic Information >	First level prompt for diagnostic information. Has subset level.	—	—
↕Device	Device type number.	RM78XXX, R7140, or EC78XXX	—
↕Device Suffix	Device suffix number.	nnnn	—
↕Run/Test Sw.	Position of Run/Test Switch.	RUN or TEST	Indicates if 7800 SERIES is in RUN or TEST mode.
↕OperControl T6	Operating Control Input.	= 1 or 0	Indicates if input is on or off, energized or de-energized.
↕Interlock T7	Running/Lockout Interlock.	= 1 or 0	Indicates if input is on (1) or off (0), energized or de-energized.
↕Pilot Valve	T8 Pilot Valve.	= 1 or 0	Indicates if output terminal is on or off, energized or de-energized.
↕Main Valve	T9 Main Fuel Valve.	= 1 or 0	Indicates if output terminal is on or off, energized or de-energized.
↕Ignition	T10 Ignition.	= 1 or 0	Indicates if output terminal is on or off, energized or de-energized.
↕LowFire Sw	T18 Low Fire Switch.	= 1 or 0	Indicates if input is on or off, energized or de-energized.
↕HighFireSw	T19 High Fire Switch.	= 1 or 0	Indicates if input is on or off, energized or de-energized.
↕PreIgn ILK	T20 or T17 ^b Pre-Ignition Interlock	= 1 or 0	Indicates if input is on or off, energized or de-energized.

Table 3. Selectable Messages. (Continued)

Selectable Message/Display	Description	Possible States/ Range (Terminals)	Comments
↕Valv/Start	T21 Interrupted/Intermittent Pilot Valve, First Stage Oil Valve or Start Input.	= 1 or 0	Indicates if output is on or off, energized or de-energized.
↕Jumper 1	Pilot Flame Establishing Period (PFEP).	INTACT/CLIPPED	Display shows state of PFEP jumper. If jumper is intact, 7800 SERIES was 10 second PFEP. If jumper is clipped, 7800 SERIES has 4 second PFEP.
	First Safety Time (for RM/ EC7850).	INTACT/CLIPPED	Display shows state of First Safety Time (EC7850) jumper. If jumper is intact, EC7850 has 5 second First Safety Time. If jumper is clipped, the EC7850 has 3 second First Safety Time.
↕Jumper 2	Pilot Valve.	INTACT/CLIPPED	Display shows state of Pilot Valve (terminal no. 21). If jumper is intact, RM7800G has Intermittent Pilot Valve. If jumper is clipped, RM7800G has 15 or 30 second Interrupted Pilot Valve.
	Main Trial Time (for RM/ EC7850).	INTACT/CLIPPED	Display shows state of Main Trial Time (EC7850)Valve (terminal no. 21). If jumper is intact, EC7850 has 5 second Main Trial Time. If jumper is clipped, EC7850 has 3 second Main Trial Time.
↕Jumper 3	Start-up Airflow Switch (AFS) check.	INTACT Disabled/CLIPPED Enabled	Display shows state of Start-up AFS check jumper. If jumper is clipped, RM7800 AFS check is enabled and if jumper is intact, AFS check is disabled.
↕Amp Type	Defines type of amplifier installed.	STANDARD/AMP-CHECK/ SHUTTER	Display shows type of flame detection system installed (i.e., as STANDARD, AMP-CHECK/ AMPLI-CHECK™ and SHUTTER/ Dynamic Self-Checking).
↕Flame Response	Amplifier Flame Failure Response Time (FFRT) in seconds.	0.8 second, 1 second, 2 seconds, or 3 seconds	—
↕Purge Time	Timing value of purge card.	mm:ss	Two seconds to 30 minutes.

^aEuropean Approved Controls.

^bPre-Ignition Interlock Terminal 17 or 20 is model dependent.

^cValve Proving Device or RM7897.

^dThe display values are as follows:

n represents a numbered value.

T represents the terminal number.

x represents the suffix letter of the Relay Module.

Expanded Annunciator Messages (Table 4)

The Expanded Annunciator (EA) may or may not be connected because it is an optional device. If the EA is not connected, a display message of "(EA not connected)" is shown. If the EA is connected, display messages are shown; see Table 4 (Note that 1 means ON and 0 means OFF). When accessing Expanded Annunciator messages, follow the same operations as used with the Selectable messages.

Table 4. Expanded Annunciator.

Selectable Message ^a (Second Line)	Display Value (Second Line)	First Line Message
Expanded Annunciator↔		
↕Expanded Annunciator (EA not connected)<		↓EA
↕Current Status (CS:) ^a	EA Message<	↓EA
↕Valve Closure (Valve Close)	T5 = 1 or 0<	↓EA
↕Burner Switch (Burner Sw.)	T5 = 1 or 0<	↓EA
↕Operating Control (OperControl)	T6 = 1 or 0<	↓EA
↕Auxiliary Limit (Aux Limit 1)	T7 = 1 or 0<	↓EA
↕Auxiliary Limit (Aux Limit 2)	T8 = 1 or 0<	↓EA
↕Low water Cutoff (LWCO)	T9 = 1 or 0<	↓EA
↕High Limit (High Limit)	T10 = 1 or 0<	↓EA
↕Auxiliary Limit (AuxLimit 3)	T11 = 1 or 0<	↓EA
↕Oil Selection Switch (Oil Select)	T12 = 1 or 0<	↓EA
↕High Oil Pressure Switch (Hi OilPres)	T13 = 1 or 0<	↓EA
↕Low Oil Pressure Switch (LowOilPres)	T14 = 1 or 0<	↓EA
↕High Oil Temperature Switch (Hi OilTemp)	T15 = 1 or 0<	↓EA
↕Low Oil Temperature Switch (LowOilTemp)	T16 = 1 or 0<	↓EA
↕Atomizing Switch (Atomize Sw)	T19 = 1 or 0	↓EA
↕Gas Selection Switch (Gas Select)	T17 = 1 or 0<	↓EA
↕High Gas Pressure Switch (Hi GasPres)	T18 = 1 or 0<	↓EA
↕Low Gas Pressure Switch (LowGasPres)	T19 = 1 or 0<	↓EA
↕Airflow Switch (Airflow Sw)	T20 = 1 or 0<	↓EA
↕Auxiliary Interlock (Aux ILK 4)	T21 = 1 or 0<	↓EA
↕Auxiliary Interlock (Aux ILK 5)	T22 = 1 or 0<	↓EA
↕EA Fault Code	nnn<	↓EA
↕Software Revision (SW Rev.)	nnnn<	↓EA

^a See Table 8 for optional messages.

TROUBLESHOOTING

After the KDM is installed, return the 7800 SERIES to normal operation, restore power and run the system through at least one complete automatic cycle. For complete Troubleshooting and System Checkout information, see form 65-0229.

7800 SERIES System Diagnostics

Troubleshooting control system equipment failures is made easier with the 7800 SERIES self-diagnostics and first-out annunciation. The S7800 provides visual annunciation by displaying a fault code and fault or hold message on the display.

Self-diagnostics of the 7800 SERIES enables it to detect and annunciate both external and internal system problems. Internal faults and external faults such as interlock failures, flame failures and false flame signals are annunciated by the KDM via the 7800 SERIES Relay Module.

The KDM displays a sequence status message indicating STANDBY, PREPURGE, PRE-IGNITION, SAFETY 1, PILOT IGN, PILOT STAB., MAIN IGN, RUN or POSTPURGE, as appropriate. The selectable messages also provide visual indication of current status and historical status of the equipment, such as: Flame Signal, Total Cycles, Total Hours, Fault History, Diagnostic Information and Expanded Annunciator terminal status (if used). With this information, most problems can be diagnosed without extensive trial-and-error testing.

Table 21 provides the sequence and status hold messages.

Table 5. Keyboard Display Module Sequence and Status Hold Messages.

Sequence	Status
INITIATE mm:ss	The Keyboard Display Module (KDM) indicates the burner status, INITIATE, a stabilization period for the relay module to check for any fluctuations in ac line voltage inputs or control inputs on power up or during normal operation. The timing of the INITIATE period is either two seconds or ten seconds, depending on the model, before entering STANDBY.
If the relay module is in an INITIATE HOLD status, the following conditions could exist:	
INITIATE HOLD: (AC Frequency/Noise)	The KDM indicates the burner status and that it is waiting for excess line noise to clear up, which prevents sufficient reading of the line voltage inputs. The burner sequence does not advance into STANDBY until the excess line noise ceases or a line frequency error occurs; this is caused by using a 60 Hz device on a 50 Hz line, or vice versa on devices with a date code earlier than 9804, is corrected.
INITIATE HOLD: (AC Line Dropout)	The KDM indicates the burner status and that ac line power has momentarily dropped out. The burner sequence does not advance into STANDBY until the ac line voltage has stabilized throughout the INITIATE sequence.
INITIATE HOLD: (AC Frequency)	The KDM indicates the burner status and that line frequency is faster than the expected value. The burner sequence does not advance into STANDBY until the line frequency returns to the proper value; this is perhaps caused by using a 60 Hz device on a 50 Hz line for devices with a date code earlier than 9804.
INITIATE HOLD: (Low Line Voltage)	The KDM indicates the burner status and that low line voltage (10% lower than rated voltage) has occurred. The burner sequence does not advance into STANDBY until the line voltage is at a sufficient level for proper operating parameters.
STANDBY	The KDM indicates the burner status, STANDBY. The burner can be placed in STANDBY by opening the burner switch or if the operating controller indicates its setpoint is satisfied. If a demand is present for burner operation, the burner sequence does not advance from STANDBY to PURGE until the recycle limits close. If an Expanded Annunciator is connected, the display messages are enhanced.
If the relay module is in a STANDBY HOLD status, the following conditions could exist:	
STANDBY HOLD: F/G (Flame Detected)	The KDM indicates the burner status and that a flame is detected. A demand is present for burner operation. The sequence does not advance to PREPURGE until the flame signal clears. If the flame signal does not clear within 40 seconds, the relay module locks out.
STANDBY HOLD: T20 (Pre-Ignition Interlock)	The KDM indicates the burner status and that the Pre-Ignition Interlock is not closed. A demand is present for burner operation, but the burner sequence does not advance to PREPURGE until the Pre-Ignition Interlock proves closed. If this time exceeds a 30 second hold, the relay module locks out.
STANDBY HOLD: T7 (Lockout Interlock)	The KDM indicates the burner status and that the Lockout Interlock is closed. A demand is present for burner operation, but the burner sequence does not advance to PREPURGE until the Lockout Interlock proves open. If this time exceeds the 120 second hold, the relay module locks out.
STANDBY HOLD: T7 (Running Interlock) EC/RM7850	The KDM indicates the burner status and that the Running Interlock is closed. A demand is present for burner operation, but the burner sequence does not advance to PREPURGE until the Running Interlock proves open. If this time exceeds the 120 second hold, the relay module locks out.
PURGE	The KDM indicates the burner status, PURGE, which is the period of time the blower motor is running before the Ignition period. The timing of the PURGE period is selectable.
If the relay module is in a PURGE HOLD status, the following conditions could exist:	
PURGE HOLD: T19 (High Fire Switch)	The KDM indicates the burner status and that the High Fire Switch is not closed. The firing rate motor is driving to its PURGE rate position. If this time exceeds four minutes and fifteen seconds, the relay module locks out.
PURGE DELAY: T19 (High Fire Switch Jumpered)	The KDM indicates the burner status and that the High Fire Switch is jumpered. The High Fire Switch is bypassed, welded or otherwise prematurely closed. The system automatically adds 30 seconds to allow the firing rate motor additional drive time to reach or near the open damper position before starting the PURGE sequence.
PURGE HOLD: TEST (Run/Test Switch)	The KDM indicates the burner status and that the Run/Test Switch is in the TEST position. The sequence does not continue until the Run/Test Switch is placed in the RUN position.
PURGE HOLD: T18 (Low Fire Switch Jumpered)	The KDM indicates the burner status and that the Low Fire Switch is jumpered. The Low Fire Switch is bypassed, welded or otherwise prematurely closed. The system automatically adds 30 seconds to allow the firing rate motor additional drive time to reach or near the closed damper position before starting the ignition sequence.
PURGE HOLD: F/G (Flame Detected)	The KDM indicates the burner status and that a flame is detected. The burner sequence does not advance through PREPURGE because a flame is detected as being present. The sequence holds waiting for the flame signal to clear. If the time exceeds 30 seconds, the relay module locks out.

Table 5. Keyboard Display Module Sequence and Status Hold Messages. (Continued)

Sequence	Status
PURGE HOLD: T18 (Low Fire Switch)	The KDM indicates the burner status and that the Low Fire Switch is not closed. The firing rate motor is driving to its Low Fire position in preparation for Ignition Trials. If this time exceeds four minutes and fifteen seconds, the relay module locks out.
PURGE HOLD: T7 (Running Interlock)	The KDM indicates the burner status and that the Running Interlock is not closed. The sequence does not advance to ignition until the Running Interlock proves closed. If this time exceeds 30 seconds, the relay module locks out.
PILOT IGN mm:ss	The KDM indicates the burner status, PILOT IGN, and the timing of the PILOT IGN trial begins, in seconds. During this period, the relay module permits the pilot valve to open and the pilot flame to establish.
If the relay module is in a PILOT HOLD status, the following conditions could exist:	
PILOT HOLD: TEST (Run/Test Switch)	The KDM indicates the burner status, PILOT IGN, and that the Run/Test Switch is in the TEST position. The sequence does not continue until the Run/Test Switch is placed in the RUN position.
MAIN IGN mm:ss	The KDM indicates the burner status, MAIN IGN, and the timing of the MAIN IGN trial begins, in seconds. During this period, the relay module permits the main valve to open and the main flame to establish.
RUN	The KDM indicates the burner status, RUN, which is the period of time after the Ignition Trials and before the operating controller setpoint is reached. During this time, the burner is firing under control of the firing rate control.
If the relay module is in a RUN HOLD status, the following condition could exist:	
RUN LOWFIRE: TEST (Run/Test Switch)	The KDM indicates the burner status and that the Run/Test Switch is in the TEST position. Normal modulation or operation does not continue until the Run/Test Switch is placed in the RUN position.
POSTPURGE mm:ss	The KDM indicates the burner status, POSTPURGE, which is the period of time after the RUN period when the blower motor continues to run. The timing of the POSTPURGE period is fifteen seconds.
Waiting for connection...	The KDM has power but is waiting to receive a signal from the relay module to continue operation.
RESET/ALARM TEST	The KDM indicates the burner status, RESET/ALARM TEST. This condition indicates that the reset button is pressed. If it is held for more than four seconds, the alarm output is energized. The alarm output is de-energized when the reset button is released.
Additional Sequence Status Information When An Expanded Annunciator is Connected to the Relay Module:	
BURNER OFF: T6 (Burner Switch)	The KDM indicates the Burner Switch is not closed. The burner sequence does not advance to PREPURGE until the Burner Switch closes.
STANDBY	The KDM indicates the burner status, STANDBY, and that the Operating Control is not closed. The burner sequence does not advance to PREPURGE until the Operating Control closes.
STANDBY HOLD: T6 (EA Hold Message)	The KDM indicates the burner status, STANDBY, and that a limit is not closed. The burner sequence does not advance to PREPURGE until one or all limits close downstream from the Operating Control.
STANDBY HOLD: T6 (Circuit Fault)	The KDM indicates the burner status, STANDBY, and that the control input is not closed. The burner sequence does not advance to PREPURGE until the control input closes.

The S7800 provides diagnostic information to aid the service mechanic in obtaining information when troubleshooting the system. See Table 6 for information on accessing historical and diagnostic selectable messages. Information available in the Diagnostic Information includes Device Type, Device Suffix, Software Revision, Manufacturing Code, Flame Amplifier Type, Flame Failure Response Time (FFRT), Selectable Jumper Configuration Status, Run/Test Switch Status and Terminal Status.

Historical Information Index

The S7800 displays historical information for the six most recent lockouts. Each of the six lockout records retains the cycle when the fault occurred, a fault code, a fault message, and burner status when the fault occurred. See Table 6. The Fault History is NOT available if the Service Call Feature is active.

Table 6. Accessing Historical and Diagnostic Selectable Messages.

Step	Operation	Press	Display	Comments
1.	Press $\uparrow\downarrow$ keys to access Diagnostic Information.	$\uparrow\downarrow$	STANDBY Diagnostic Info>	Use the Down/Up SCROLL keys to access the selectable message. The second line will display Diagnostic Information.
2.	Press $\leftarrow\rightarrow$ key to Access Diagnostic Information.	$\leftarrow\rightarrow$	STANDBY Diagnostic Info>	Use the Change Level key to access the Diagnostic Information.
3.	Continue display of Diagnostic Information.	$\uparrow\downarrow$	STANDBY ∇ DI Device RM7800<	Push the SCROLL key to scroll to the next Diagnostic Message.
4.	Continue through remaining Diagnostic Information display following step 3 as required.	—	—	—
5.	Press the $\leftarrow\rightarrow$ key to return to the first level of Diagnostic Information data prompt or to other selectable messages.	$\leftarrow\rightarrow$	STANDBY Diagnostic Info>	Another display can be selected or discontinue accessing Diagnostic Information review.

SERVICE NOTE: If the Keyboard Display Module screen is scrambled, remove and reinstall the Keyboard Display Module and reset the 7800 SERIES Relay Module.

SERVICE NOTE: Reset the 7800 SERIES Relay Module by pressing the reset push button on the relay module or pressing a remote reset push button wired through the Keyboard Display Module, Data ControlBus™ Module or Remote Reset Module. A power-up reset will cause an electrical reset of the 7800 SERIES Relay Module but will not reset a lockout condition.

Lockout Messages

When the 7800 SERIES is locked out, it displays a repeating cycle of messages unless the Call Service Feature is Active. Then the Fault message is displayed followed by the Customer Service message. The Fault History is NOT available if the Call Service is Active. See Table 7. There are four states in the cycle:

1. State 1 (Fig. 16). A first state message display lasts six seconds. First line displays the word LOCKOUT followed by the fault code number and possibly a lower case letter if an Expanded Annunciator is connected. The letter corresponds to the first-out code supplied by the Expanded Annunciator. The lockout reason corresponding to the fault code number is displayed on the second line, highlighted by asterisks on each side.

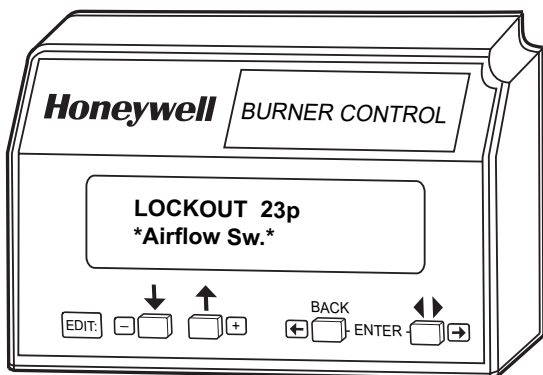

Fig. 16. Lockout message, State 1.

2. State 2 (Fig. 17). Display of the second state message lasts two seconds.

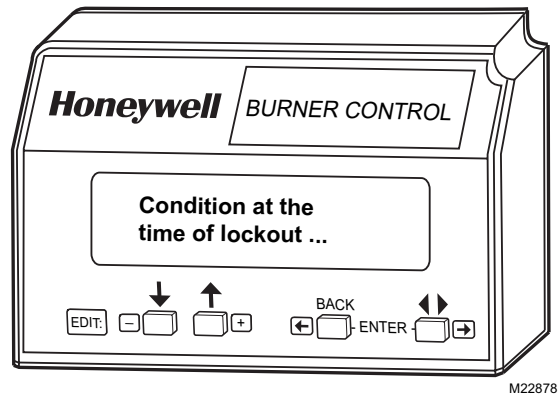

Fig. 17. Lockout message, State 2.

3. State 3 (Fig. 18). Display of the third state message lasts three seconds. It is a replica of the burner status as it existed at the time of the lockout. The second line is blank if the burner status at the time of lockout did not include a preemptive message (in parentheses) for the second line.

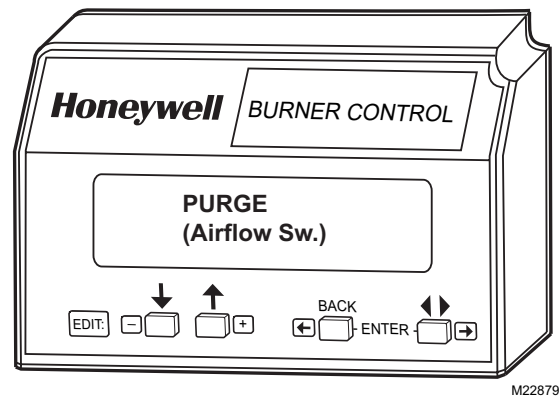

Fig. 18. Lockout message, State 3.

4. State 4: In the fourth state, both lines are blanked for one-half second, then the display sequences to the first state.

NOTE: For further explanation of Lockout Messages, Troubleshooting and Checkout, refer to form 65-0229.

Table 7. Hold and Fault Message Summary.

Fault Code	System Failure	Recommended Troubleshooting
Fault 1 *No Purge Card*	No card is plugged into the purge card slot.	<ol style="list-style-type: none"> 1. Make sure the purge card is seated properly. 2. Inspect the purge card and connector on the relay module for damage or contaminants. 3. Reset and sequence the relay module. 4. If the fault code reappears, replace the purge card. 5. Reset and sequence the relay module. 6. If the fault persists, replace the relay module.
Fault 2 *AC Frequen/Noise	Excess noise or device running on slow ac.	<ol style="list-style-type: none"> 1. Check the relay module and display module connections. 2. Reset and sequence the relay module. 3. Check the relay module power supply and make sure that both frequency and voltage meet the specifications. 4. Check the backup power supply, as appropriate.
Fault 3 *AC Line Dropout	Ac line dropout detected.	
Fault 4 *AC Frequency*	Device running on fast ac.	
Fault 5 *Low Line Voltage*	Low ac line detected.	
Fault 6 *Purge Card Error*	Purge card timing changed since card was initially read.	<ol style="list-style-type: none"> 1. Make sure the purge card is seated properly. 2. Inspect the purge card and connector on the relay module for damage or contaminants. 3. Reset and sequence the relay module. 4. If the fault code reappears, replace the purge card. 5. Reset and sequence the relay module. 6. If the fault persists, replace the relay module.
Fault 7 *Flame Amplifier*	Flame sensed when flame not present.	<ol style="list-style-type: none"> 1. Check wiring and correct any errors. Make sure that the flame sensor wires are in separate conduits. Check for noise coupling into the flame detector leadwires. 2. Make sure that flame detector and flame amplifier are compatible. 3. Remove the flame amplifier and inspect connections. Reset the flame amplifier. 4. Reset and sequence the relay module. 5. If the code reappears, replace the amplifier. 6. If the fault persists, replace the flame detector. 7. If the fault persists, replace the relay module.
Fault 8 *Flame Amp/Shutr*	Flame sensed when no signal expected during shutter-check or Ampli-Check™ versions.	
Fault 9 *Flame Detected*	Flame sensed when no flame is expected during STANDBY.	<ol style="list-style-type: none"> 1. Check that flame is not present in the combustion chamber; correct any errors. 2. Check wiring and correct any errors. Make sure that flame sensor wires are in separate conduits. Check for noise coupling into flame detector leadwires. 3. Remove the flame amplifier and inspect its connections. Reset the amplifier. 4. Reset and sequence the relay module. 5. If the code reappears, replace the amplifier and/or the flame detector. 6. If the fault persists, replace the flame detector. 7. If the fault persists, replace the relay module.
Fault 10 *Pre-Ignition ILK*	Pre-Ignition Interlock fault during STANDBY	<ol style="list-style-type: none"> 1. Check wiring and correct any errors. 2. Check Pre-Ignition Interlock switches to assure proper functioning. 3. Check fuel valve operation. 4. Reset and sequence the relay module; monitor the Pre-Ignition Interlock status. 5. If the code persists, replace the relay module.

Table 7. Hold and Fault Message Summary. (Continued)

Fault Code	System Failure	Recommended Troubleshooting
Fault 11 *Running ILK On*	Running Interlock powered at improper sequence point.	<ol style="list-style-type: none"> 1. Check wiring to make sure that interlocks are connected properly between terminals 6 and 7. Correct any errors. 2. Reset and sequence the relay module. 3. If the fault persists, measure the voltage between terminals 6 and L2(N) (ground), then terminals 7 and L2(N). If there is line supply voltage present at terminal 6 when the controller is off, the controller switch may be bad or jumpered. 4. If steps 1 through 3 are correct and there is line supply voltage present at terminal 7 when the controller is closed and the fault persists, check for a welded or jumpered Running Interlock, Lockout Interlock, or Airflow Switch. Correct any errors. 5. If steps 1 through 4 are correct and the fault persists, replace the relay module.
Fault 12 *Lockout ILK On*	Lockout Interlock powered at improper sequence point.	
Fault 13 *Airflow Sw. On*	Combustion airflow interlock fault during STANDBY.	
Fault 14 *High Fire Sw.*	High Fire Interlock Switch failure to close during PREPURGE.	<ol style="list-style-type: none"> 1. Check wiring and correct any errors. 2. Reset and sequence the relay module. 3. Use either the manual motor potentiometer to drive the motor to the High Fire position or use the Run/Test Switch option, if available. Sequence to Prepurge drive to High Fire and place in the Test position. Adjust the High Fire Switch while in this state to make sure that it closes properly. 4. Measure the voltage between terminal 19 and L2(N) while in the Prepurge drive to High Fire state. Line supply voltage should be present. If not, the switch adjustment is incorrect and/or the switch is defective and needs replacing. 5. Reset and sequence the relay module. If the line supply voltage was present between the High Fire Switch and terminal 19, and the fault still persists, replace the relay module.
Fault 15 *Flame Detected*	Flame sensed when no flame is expected during STANDBY.	<ol style="list-style-type: none"> 1. Check that the flame is not present in the combustion chamber; correct any errors. 2. Make sure that the flame amplifier and flame detector are compatible. 3. Check wiring and correct any errors. 4. Remove the flame amplifier and inspect the connections. Reset the flame amplifier. 5. Reset and sequence the relay module. 6. If the code reappears, replace the amplifier and/or the flame detector. 7. If the fault persists, replace the relay module.
Fault 16 *Flame-Out Timer*	No-flame detected during Pilot Flame Establishing Period.	<ol style="list-style-type: none"> 1. Measure the flame signal. If one exists, make sure it meets specifications. Make any necessary burner adjustments using manufacturer instructions. 2. Make sure that the flame amplifier and flame detector are compatible. 3. If the code reappears, replace the amplifier and/or the flame detector. 4. If the fault persists, replace the relay module.
Fault 17 *Main Flame Fail*	Main flame failure during RUN after flame is established and on for at least 10 seconds.	<ol style="list-style-type: none"> 1. Inspect the main fuel valve(s) and connection(s). 2. Make sure that the fuel pressure is high enough to supply fuel to the combustion chamber. 3. Check the flame detector sighting for adequate flame signal throughout the burner firing rate.
Fault 18 *Flame Detected*	Flame sensed when the shutter is open and no flame is expected during PREPURGE.	<ol style="list-style-type: none"> 1. Check that flame is not present in the combustion chamber. Correct any errors. 2. Make sure that the flame amplifier and flame detector are compatible. 3. Check the wiring and correct any errors. Make sure F and G wires are in individual conduits and protected from stray noise pickup. 4. Remove the flame amplifier and inspect the connectors. Reset the flame amplifier. 5. Reset and sequence the relay module. 6. If the code reappears, replace the flame amplifier and/or the flame detector. 7. If the fault persists, replace the relay module.

Table 7. Hold and Fault Message Summary. (Continued)

Fault Code	System Failure	Recommended Troubleshooting
Fault 19 *Main Flame Ign.*	Flame was lost during MFEP or the first 10 seconds of the RUN state.	<ol style="list-style-type: none"> 1. Inspect the main fuel valve(s) and connection(s). 2. Make sure the fuel pressure is high enough to supply fuel to the combustion chamber. 3. Make sure the flame detector is positioned to obtain the required flame signal strength; reset and recycle.
Fault 20 *Low Fire Sw. Off*	Low Fire Interlock switch failure to close during PREPURGE.	<ol style="list-style-type: none"> 1. Check wiring and correct any errors. 2. Reset and sequence the relay module. 3. Use either the manual motor potentiometer to drive the motor to the Low Fire position or use the Run/Test Switch option, if available. Sequence to Prepurge drive to Low Fire and place in the Test Position. Adjust the Low Fire Switch to make sure it closed properly. 4. Measure the voltage between terminal 18 and L2(N) while in the Prepurge drive to Low Fire state. Line supply voltage should be present. If not, the switch adjustment is incorrect and/or the switch is defective and needs replacing. 5. Reset and sequence the relay module. If line supply voltage was present between the Low Fire Switch and terminal 18, and the fault still persists, replace the relay module.
Fault 21 *Running ILK*	Running Interlock fault during PREPURGE.	<ol style="list-style-type: none"> 1. Check wiring and correct any errors. 2. Inspect the fan; make sure there is no blockage of the air intake and that it is supplying air. 3. Make sure the Interlock Switches are working properly and that all switch contacts are free of contaminants. 4. Reset and sequence the relay module to PREPURGE (place the Run/Test Switch in the Test position, if available). Measure the voltage between terminals 7 and L2(N). Line voltage should be present. 5. If steps 1 through 4 are correct and the fault persists, replace the relay module.
Fault 22 *Lockout ILK*	Lockout Interlock fault during PREPURGE.	
Fault 23 *Airflow Switch*	Combustion airflow interlock fault during PREPURGE.	
Fault 24 *Call Service*	The flame interlock (relay module) was on when it should be off.	<ol style="list-style-type: none"> 1. Check for F leadwire routing. Make sure routing is in its conduit and isolated from noise-producing circuits.
Fault 25 *Call Service*	The flame interlock (relay module) was off when it should be on.	
Fault 26 *Man-Open Sw. Off*	The Manual Open Valve Switch was off when it should be on (Device specific).	<ol style="list-style-type: none"> 1. Check wiring and correct any errors. 2. Make sure that the Manual Open Valve Switch is fully open. 3. Make sure that the Manual Open Valve Switch is functioning properly and that the switch contacts are free from contaminants. 4. Reset and sequence the relay module. 5. Make sure that the Manual Open Valve Switch provides an electrical path when closed. Verify that the relay module is receiving power at terminal 17. 6. If steps 1 through 5 are correct and the fault persists, replace the relay module.
Fault 27 *Start Switch On*	Start Switch was on during PREPURGE (Device specific).	<ol style="list-style-type: none"> 1. Start Switch held on too long. 2. Check wiring; verify that Start Switch is correctly connected. 3. Make sure that the Start Switch is functioning properly and that the switch contacts are free of contaminants. 4. Reset and sequence the relay module to PREPURGE; set the Run/Test Switch to Test. Make sure there is no power at terminal 6 during PREPURGE. 5. If steps 1 through 4 are correct and the fault persists, replace the relay module.
Fault 28 *Pilot Flame Fail*	Pilot flame failure.	<ol style="list-style-type: none"> 1. Check pilot valve wiring and operation. Correct any errors. 2. Check fuel supply. 3. Check pilot pressure and repeat pilot turndown test. 4. Check ignition transformer electrode, flame detector, flame detector sighting and flame amplifier. 5. If steps 1 through 4 are correct and the fault persists, replace the relay module.

Table 7. Hold and Fault Message Summary. (Continued)

Fault Code	System Failure	Recommended Troubleshooting
Fault 29 *Lockout ILK*	Lockout Interlock fault.	<ol style="list-style-type: none"> 1. Check wiring and correct any errors. 2. Inspect the fan; make sure that there is no blockage of the air intake and that it is supplying air. 3. Make sure that the Lockout Interlock Switches are working properly and that all switch contacts are free from contaminants. 4. Reset and sequence the relay module to PREPURGE (place the Run/Test Switch in the Test position, if available). Measure the voltage between terminals 7 and L2(N). Line voltage should be present. 5. If steps 1 through 4 are correct and the fault persists, replace the relay module.
Fault 30 *Running ILK*	Running Interlock fault.	<ol style="list-style-type: none"> 1. Inspect the Running Interlocks, including the Airflow Switch, and the connections. 2. Make sure that the Running Interlocks, including the Airflow Switch, are functioning properly and that switch contacts are free from contaminants. 3. Reset and sequence the relay module to PREPURGE. Set the Run/Test Switch, if available, to Test. Measure the voltage between terminal 7 and L2(N). Line voltage should be present. 4. If steps 1 through 3 are correct and the fault persists, replace the relay module.
Fault 31 *Low Fire Sw. Off*	Low Fire Interlock Switch failure to close during RUN (Device specific).	<ol style="list-style-type: none"> 1. Check wiring and correct any errors. 2. Reset and sequence the relay module. 3. Use either the manual motor position to drive the motor to the Low Fire position, or use the Run/Test Switch option, if available. Sequence to Run drive to Low Fire and place the switch in the Test position. Adjust the Low Fire Switch while in this state to make sure it is closing properly. 4. While in Run, drive to Low Fire state, measure the voltage between terminal 18 and L2(N). Line voltage should be present. If not, the switch adjustment is incorrect and/or the switch is defective and needs replacement. 5. Reset and sequence the relay module. If line voltage was present between the Low Fire Switch and terminal 18, and the fault persists, replace the relay module.
Fault 32 *Airflow Switch*	Combustion Airflow Interlock fault.	<ol style="list-style-type: none"> 1. Check wiring and correct any errors. 2. Inspect the fan; make sure there is no blockage of the air intake and it is supplying air. 3. Make sure the Airflow Interlock Switches are working properly and all switch contacts are free from contaminants. 4. Reset and sequence the relay module to PREPURGE. Place the Run/Test Switch in the Test position, if available. Measure the voltage between terminals 7 and L2(N). Line voltage should be present. 5. If steps 1 through 4 are correct and the fault persists, replace the relay module.
Fault 33 *Pre-Ignition ILK*	Pre-Ignition Interlock fault.	<ol style="list-style-type: none"> 1. Check wiring and correct any errors. 2. Inspect the Pre-Ignition Interlock switches and make sure they function properly. 3. Check fuel valve operation. Valve must close within five seconds. 4. Reset and sequence the relay module. 5. During STANDBY or PREPURGE, measure the voltage between terminal 20 and L2(N). Line voltage should be present. If not, the Pre-Ignition Interlock switches can be defective and need replacing. 6. If the fault persists, replace the relay module.
Fault 34 *Control On*	CTL input was energized at the wrong time for the relay module. This fault implies a field wiring error.	<ol style="list-style-type: none"> 1. Check wiring and correct any errors. 2. Reset and sequence the relay module. 3. If fault persists, replace the relay module.

Table 7. Hold and Fault Message Summary. (Continued)



Fault Code	System Failure	Recommended Troubleshooting
Fault 35 *Call Service*	Safety relay was off when it should be on or the internal fuse has blown.	<ol style="list-style-type: none"> 1. Reset and sequence the relay module. If fault repeats, replace relay module, but be sure to test for excessive loads on appropriate terminals described by fault code. 2. If fault does not repeat on next cycle, check for electrical noise being coupled into the relay module through the loads on appropriate terminals described by the fault code. 3. Possibly check for bouncing running on Lockout Interlock. 4. If fault persists, replace the relay module.
Fault 36 *Call Service*	Main valve terminal was off when it should be on, or the internal fuse has blown.	
Fault 37 *Call Service*	Pilot (ignition) valve terminal was off when it should be on, or the internal fuse has blown.	
Fault 38 *Call Service*	Ignition terminal was off when it should be on, or the internal fuse has blown.	
Fault 39 *Call Service*	V2S valve terminal (usually terminal 21) was off when it should be on, or the internal fuse has blown.	
Fault 40 *Call Service*	Safety relay was on when it should be off.	 WARNING Explosion Hazard. Can cause severe injury, death or property damage. <ol style="list-style-type: none"> 1. Remove system power, turn off fuel supply. 2. Check for wiring errors that could provide power to terminals described by the fault. Correct any errors. 3. Re-power system; reset and sequence the relay module. 4. If fault persists, replace the relay module. 5. When fault is corrected, turn on fuel supply.
Fault 41 *Main Valve On*	Main valve terminal was on when it should be off.	
Fault 42 *Pilot Valve On*	Pilot (ignition) valve terminal was on when it should be off.	
Fault 43 *Ignition On*	Ignition terminal was on when it should be off.	
Fault 44 *Pilot Valve 2 On*	V2S valve terminal, used as a pilot, is on when it should be off.	
Fault 45 *Low Fire Sw. Off*	Low Fire Interlock switch failure to close or stay closed.	<ol style="list-style-type: none"> 1. 1. Check wiring and correct any errors. 2. 2. Reset and sequence the relay module. 3. 3. Use either the manual motor position to drive the motor to the Low Fire position, or use the Run/Test Switch option, if available. Sequence to Run, drive to Low Fire and place in the Test position. Adjust the Low Fire Switch while in this state to make sure it is closing properly. 4. 4. While in Run, drive to Low Fire state, measure the voltage between terminal 18 and L2(N). Line voltage should be present. If not, the switch adjustment is incorrect and/or the switch is defective and needs replacement. 5. 5. If steps 1 through 4 are correct and the fault still persists, replace the relay module.
Fault 46 *Flame Amp Type*	Device specific.	<ol style="list-style-type: none"> 1. Remove power to the device. 2. Reset the flame amplifier and reset and sequence the relay module.
Fault 47 *Jumpers Changed*	The configuration jumpers differ from the sample taken at startup.	<ol style="list-style-type: none"> 1. Inspect the jumper connections. Make sure that clipped jumpers are completely removed. 2. Reset and sequence the relay module. 3. If fault persists, replace the relay module.
Fault 48 *Delayed MV On* (2nd Stage Valve)	V2S valve terminal, used as a delayed main valve, was on when it should be off.	 WARNING Explosion Hazard. Can cause severe injury, death or property damage. <ol style="list-style-type: none"> 1. Remove system power, turn off fuel supply. 2. Check wiring; correct any errors. 3. Inspect the V2S Fuel Valve and its connections. Make sure the switch is working correctly and is not jumpered or welded. 4. Reset and sequence the relay module. 5. If fault persists, replace the relay module.

Table 7. Hold and Fault Message Summary. (Continued)

Fault Code	System Failure	Recommended Troubleshooting
Fault 49 *Man-Open Sw. On*	The manual open switch was on when it should be off.	 WARNING Explosion Hazard. Can cause severe injury, death or property damage. <ol style="list-style-type: none"> 1. Remove system power, turn off fuel supply. 2. Check wiring; correct any errors. 3. Inspect the Manual-Open Switch and its connections. Make sure the switch is working correctly and is not jumpered or welded. 4. Reset and sequence the relay module. 5. If fault persists, replace the relay module.
Fault 50 *Jumpers Wrong*	The sequence logic detected a combination of jumpers that is illegal for the sequence, e.g., if it is correct to clip jumper JR1 or Jumper JR2, but not both, this fault would be used when both are clipped (Device specific).	<ol style="list-style-type: none"> 1. Inspect the jumpers and refer to the installation instructions for compatible jumper configurations. 2. Make sure that clipped jumpers are completely removed. 3. Reset and sequence the relay module. 4. If fault persists, replace the relay module.
Fault 51 *Flame Too Strong*	Flame signal value is too high to be valid.	<ol style="list-style-type: none"> 1. Make sure that flame detector and flame amplifier are compatible. 2. Remove the flame amplifier and inspect the connections. Reset the flame amplifier. 3. Reset and sequence the relay module. 4. Check the flame detector sighting position, reset and cycle. 5. Verify that no ignition noise is present in the F lead due to wire routing. 6. Measure the flame strength. Verify it meets specifications. If not, refer the flame amplifier and/or flame detector checkout procedures. 7. If the code reappears, replace the flame amplifier. 8. If the code reappears, replace the flame detector. 9. If the fault persists, replace the relay module.
Fault 52 *Call Service*	Pilot Valve 2 (terminal 21) was off when it should be on.	<ol style="list-style-type: none"> 1. Inspect terminal 21 and connections. Make sure that the valve is operating properly. 2. Reset and sequence the relay module. 3. If the fault persists, replace the relay module.
Fault 53 *Lockout Switch*	Lockout Input fault (EC/RM7850 only).	<ol style="list-style-type: none"> 1. Check wiring and correct any errors. 2. Inspect the Lockout Switch to make sure it is working properly. 3. Reset and sequence the relay module. During STANDBY or PREPURGE, measure the voltage between terminal 20 and L2(N). Supply voltage should be present. If not, the lockout switch is defective and needs replacing. 4. If the fault persists, replace the relay module.
Fault 54 *Comb. Pressure*	Combustion pressure switch fault (Fulton pulse only).	<ol style="list-style-type: none"> 1. Check wiring and correct any errors. 2. Inspect the Combustion Pressure Switch to make sure it is working correctly. 3. Reset and sequence the relay module. 4. During STANDBY and PREPURGE, measure the voltage between terminal 20 and L2(N). Supply voltage should be present. If not, the Combustion Pressure Switch is defective and needs replacing. 5. If the fault persists, replace the relay module.
Fault 55 *Purge Fan Sw. On*	Purge fan switch is on when it should be off (Fulton pulse only).	<ol style="list-style-type: none"> 1. Check wiring and correct any errors. 2. Inspect the Purge Fan Switch terminal 18 and its connections. Make sure the switch is working correctly and is not jumpered or welded. 3. Reset and sequence the relay module. 4. If the fault persists, replace the relay module.

Table 7. Hold and Fault Message Summary. (Continued)

Fault Code	System Failure	Recommended Troubleshooting
Fault 56 *Block Intake*	Block intake fault (Fulton pulse only).	<ol style="list-style-type: none"> 1. Check wiring and correct any errors. 2. Inspect the Block Intake Switch and make sure it is working properly. 3. Reset and sequence the relay module. 4. During PREPURGE, measure the voltage between terminal 7 and L2(N). Supply voltage should be present. If not, the Block Intake Switch is defective and needs replacing. 5. If the fault persists, replace the relay module.
Fault 57 *Purge Fan Sw. Off*	Purge Fan Switch is off when it should be on (Fulton pulse only).	<ol style="list-style-type: none"> 1. Inspect the Prepurge Fan Switch terminal 18 and the connections. Make sure the fan is working properly. 2. Reset and sequence the relay module. 3. If the fault persists, replace the relay module.
Fault 58 *Comb. Press/Flame*	Combustion Pressure Switch or Flame Sense Fault (Fulton Pulse Only)	<ol style="list-style-type: none"> 1. If Combustion Pressure Switch is used - Terminal 20 was On when it should be Off. 2. If Flame Amplifier is used - Flame sensed when it was not expected. 3. Check wiring and correct any errors. Make sure flame sensor wires are run in separate conduits. Check for noise coupling into flame detector leadwires. 4. Remove and reinstall amplifier. 5. Reset and sequence the relay module. 6. If fault persists, remove Pressure switch connection to terminal 20 or Flame detector wire to F terminal. 7. Reset and sequence the relay module. 8. If fault persists, replace the relay module and reconnect any removed wires.
Fault 59 - 60 *Call Service*	Unused faults.	—
Fault 61	MV1 Off (Terminal 9); should be ON.	<ol style="list-style-type: none"> 1. Check wiring and correct any errors. 2. Reset and sequence the control. 3. If fault persists, replace relay module (Before installing the new relay module, verify current draw of terminal 9).
Fault 62	MV2 Off (Terminal 17); should be ON.	<ol style="list-style-type: none"> 1. Check wiring and correct any errors. 2. Reset and sequence the control. 3. If fault persists, replace relay module (Before installing the new relay module, verify current draw of terminal 17).
Fault 63	MV1 ON (Terminal 9); should be OFF.	<ol style="list-style-type: none"> 1. Check wiring and correct any errors. 2. Reset and sequence the control. 3. If fault persists, replace relay module (Before installing the new relay module, verify current draw of terminal 9).
Fault 64	MV2 ON (Terminal 17); should be OFF.	<ol style="list-style-type: none"> 1. Check wiring and correct any errors. 2. Reset and sequence the control. 3. If fault persists, replace relay module (Before installing the new relay module, verify current draw of terminal 17).
Fault 65 *VPS Off*	Valve Proving Switch (Terminal 16) OFF; should be ON. (VPS High Test)	<ol style="list-style-type: none"> 1. Check wiring and correct any errors. 2. Check MV2 for leaking valve seat. 3. Reset and sequence control.
Fault 66 *VPS On*	Valve Proving Switch (Terminal 16) ON; should be OFF. (VPS Low Test)	<ol style="list-style-type: none"> 1. Check wiring and correct any errors. 2. Check MV1 for leaking valve seat. 3. Reset and sequence control.
Fault 67 *AC Phase*	L1 and L2 miswired/exchanged (EC/RM7850 only).	<ol style="list-style-type: none"> 1. Check L1 and L2 for proper line phasing.
Fault 68 *Pre-Ignition ILK*	Pre-Ignition Interlock fault.	<ol style="list-style-type: none"> 1. Check wiring and correct any errors. 2. Inspect the Pre-Ignition Interlock switches and make sure they work properly. 3. Check fuel valve operation. Valve must close within five seconds. 4. Reset and sequence the relay module. 5. During STANDBY or PREPURGE, measure the voltage between terminal 17 and L2(N). Supply voltage should be present. If not, the Pre-Ignition Interlock switches are defective and need replacing. 6. If the fault persists, replace the relay module.

Table 7. Hold and Fault Message Summary. (Continued)

Fault Code	System Failure	Recommended Troubleshooting
Faults 69 - 70 *Call Service*	Unused faults.	—
Fault 71 *Dynamic LFS*	Low Fire Switch closed, High Fire Switch must be open (EC/RM 7850 only).	<ol style="list-style-type: none"> 1. Check firing rate position switches (usually in Modutrol® Motor) for proper operation. 2. Check wiring and correct any errors. 3. Reset and sequence the relay module. 4. If the fault persists, replace the relay module.
Fault 71 *Limits Complete*	Limit Input (terminal 7) is off when it should be on (RM7888 only).	<ol style="list-style-type: none"> 1. Check limits to make sure they are satisfied after resetting. 2. Check electrical connections to terminal 7 of wiring subbase. 3. Reset relay module. 4. If the fault persists, replace the relay module.
Fault 72 *Dynamic HFS*	High Fire Switch closed; Low Fire Switch must be open (EC/RM7850 only).	<ol style="list-style-type: none"> 1. Check firing rate position switches (usually in Modutrol® Motor) for proper operation. 2. Check wiring and correct any errors. 3. Reset and sequence the relay module. 4. If the fault persists, replace the relay module.
Fault 72 *Spec.Func.2*	Special Function 2 Input (terminal 17) is off when it should be on (Device specific).	<ol style="list-style-type: none"> 1. Check operation of Special Function 2 of PLC. 2. Check electrical connection to terminal 17 of wiring subbase and confirm presence of supply power when Special Function 2 is activated. 3. Reset relay module. 4. If the fault persists, replace the relay module.
Fault 73 *Spec.Func.3*	Special Function 3 Input (terminal 19) is off when it should be on (Device specific).	<ol style="list-style-type: none"> 1. Check operation of Special Function 3 of PLC. 2. Check electrical connection to terminal 19 of wiring subbase and confirm presence of supply power when Special Function 2 is activated. 3. Reset relay module. 4. If the fault persists, replace the relay module.
Fault 75 *Flame Proven Feedback*	Flame Indication Feedback (terminal 21) either on when it should be off or off when it should be on (Device specific).	<ol style="list-style-type: none"> 1. Remove wire to terminal 21 and reset relay module. 2. If the fault persists, replace relay module. 3. Reconnect wire to terminal 21. If the fault returns, verify wiring.
Faults 76 - 87 *Accessory Fault*	—	—
Fault 88 *Accessory Fault*	T17 powered without RM programmed.	<ol style="list-style-type: none"> 1. Program RM Valve Proving feature
Fault 89 *Accessory Fault*	T6 and T17 powered.	<ol style="list-style-type: none"> 1. Check wiring; only T6 or T17 should be powered.
Fault 90 *Accessory Fault*	T7 opens on RM7890 with VPS Feature	<ol style="list-style-type: none"> 1. Determine what interrupted terminal 7. 2. Correct any wiring issues. 3. Reset Relay Module.
Faults 91-93 *Accessory Fault	—	<ol style="list-style-type: none"> 1. —
Faults 94 - 104 *Call Service*	—	—
Fault 105 *Call Service*	Relay Module self-test failure.	<ol style="list-style-type: none"> 1. Reset and sequence the relay module. 2. If the fault reappears, remove power from the relay module and reapply the power; reset and sequence the relay module. 3. If the fault persists, replace the relay module.
Fault 106 *Call Service*	Relay Module self-test failure.	—
Fault 107 *Call Service*	Relay Module flame signal crosscheck failure.	—
Fault 108 *Call Service*	Lost E2 or device shipped unprogrammed.	<ol style="list-style-type: none"> 1. Reset control; if fault persists, replace control. 2. If device resets and operates, verify earth grounding practices.

Table 7. Hold and Fault Message Summary. (Continued)

Fault Code	System Failure	Recommended Troubleshooting
Fault 109 *Call Service*	Negative cycle test failed, earth ground absent or line voltage phasing improper.	<ol style="list-style-type: none"> 1. Make sure a good earth ground connection exists at the installation site and all earth ground connections are complete and correct. 2. Make sure the relay module and all loads operate at the same line voltage phase. 3. Reset and sequence the relay module. 4. If the fault persists, replace the relay module.
Fault 110 *Call Service*	The configuration jumpers differ from stored values.	<ol style="list-style-type: none"> 1. Inspect the jumper connections. Make sure they match the original selection and clipped jumpers are completely removed. 2. Reset and sequence the relay module. 3. If the fault persists, replace the relay module. 4. Configuration jumpers must be selected prior to 200 hours of operation. If configuration jumpers are changed after 200 hours of operation, lockout 110 occurs. Relay module <i>cannot</i> be reset and <i>must</i> be replaced.
Fault 111 *Call Service*	Relay Module configuration jumper test failure.	<ol style="list-style-type: none"> 1. Inspect the jumper connections. Make sure they match the original selection and clipped jumpers are completely removed. 2. Reset and sequence the relay module. 3. If the fault persists, replace the relay module.
Fault 112 - 126 *Call Service*	Relay Module self-test failure.	<ol style="list-style-type: none"> 1. Reset and sequence the relay module. 2. If the fault persists, replace the relay module.
Fault 127 *Call Service*	Safety relay feedback circuit was in an improper state.	<ol style="list-style-type: none"> 1. Reset and sequence the relay module. 2. If the fault persists, replace the relay module.

Expanded Annunciator Messages

If an Expanded Annunciator is wired to the limit control and interlock control strings, and connected to the 7800 SERIES Relay Module, additional hold messages, fault messages or code numbers enhance the original hold messages, fault

messages or code numbers. See the Expanded Annunciator specification, form 65-0101, for detailed information. The message demonstrates which device opened first in a monitored string of limits or interlocks.

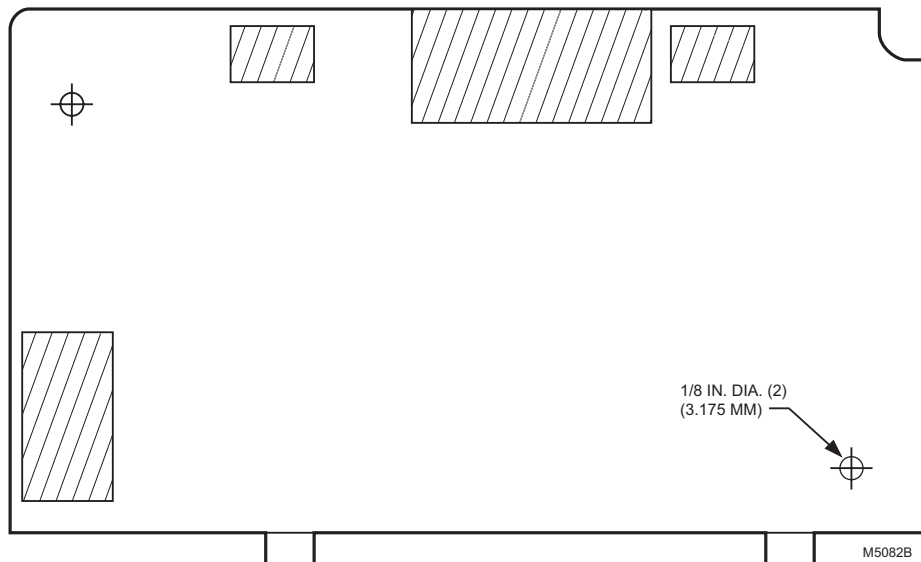

Fig. 19. KDM flush mounting outline.

APPENDIX A

Display Setup

The S7800A Keyboard Display Module (KDM) requires a password to enter the Display Setup Menu.

The Display Setup Menu offers the following functions:

- Clone—Allows the current display setup to be copied entirely to another display (Series 3 or greater)—page 25.
- MB Address—Enables the ModBus Feature and Location. The 7800 SERIES device is located on the ModBus highway. It also provides a means of system verification that ModBus is active and that this module is being addressed—page 26.
- MB Baud—Sets the data Transmit/Receive rate. The S7800 is operating on ModBus—page 27.
- Clear All—Resets the Display settings back to the factory settings—page 27.
- Password—Change current default password of 000 to a unique one the customer has selected—page 27.
- CS On/Off—Allows the Customer Service message to be displayed or the lockout message to be displayed—page 31.
- CS Test—Allows the Customer Service message to be viewed for accuracy. This will display just once—page 31.
- CS Edit—Allows for personalizing a Customer Service message. Three screens of messages are available. Each screen has two lines with 20 characters available. See Table 9 for available character text—page 37.

Display Setup—CLONE

CLONE allows copying your entire Custom Display to additional displays, Series 4 or higher.

Before you begin, you will want to build a cloning jig.

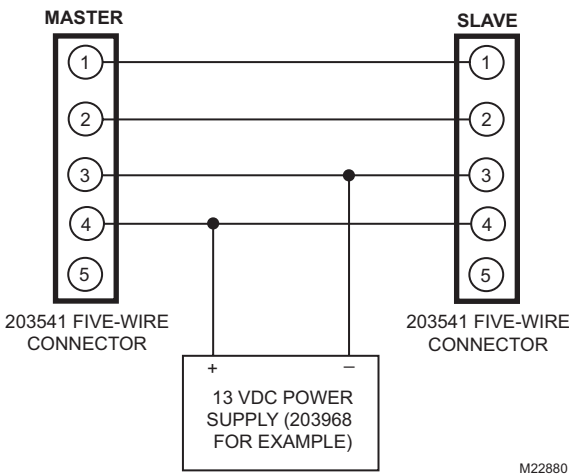

Fig. 20. Cloning jig.

To access the CLONE menu:

Press the left three buttons of the KDM for one second, then release.

DISPLAY Setup will appear. If you have a personal password, enter it to enter Setup.

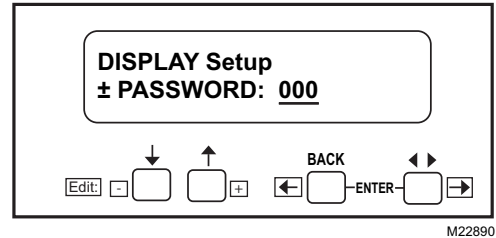

Fig. 21. Display Setup screen.

Press ENTER by pressing the two ENTER buttons at the same time.



Fig. 22. Select/Exit screen.

Choose Select.

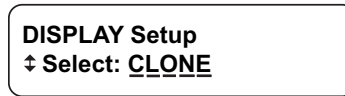

Fig. 23. Display Setup/CLONE screen.

Press ENTER by pressing the two ENTER buttons at the same time. The Select/Exit Screen (see Fig. 22) will appear. Choose Select.



Fig. 24. Clone Master screen.

The Slave display will change from Fig. 25 to many On/Off sweeps with periods of bright characters.



Fig. 25. Waiting for Connection screen.

When complete, the Slave will still be going on and off, but the Cloning Complete screen can be read (Fig. 26). Replace this Slave with additional displays that need to be cloned.



Fig. 26. Cloning Complete screen.

On the Master Display, Press ENTER, using the two ENTER buttons at the same time.

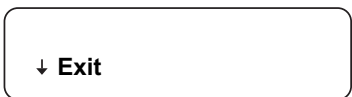

Fig. 27. Exit screen.

Choose Exit and the Master will go back to the normal menu. You will notice that the Slave being cloned will also stop flashing.

Entering the cloned device and checking items like CS Test will confirm a successful clone.

Display Setup—MB Address

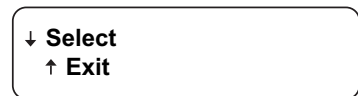

Fig. 28. Select: M B A D D R E S S, then ENTER.

With default address 00 terminals 1,2, 3 of the 203541 connector are available for the S7830 Expanded Annunciator or additional keyboard displays. With the addresses 01-99 enabled, ModBus is active and the S7830 Expanded Annunciator or additional displays will NOT work.

If the Expanded Annunciator or additional displays are required, then order the S7810M1003 ModBus card to support the ModBus Function.



Fig. 30. Press ENTER and display goes back to the following screen:

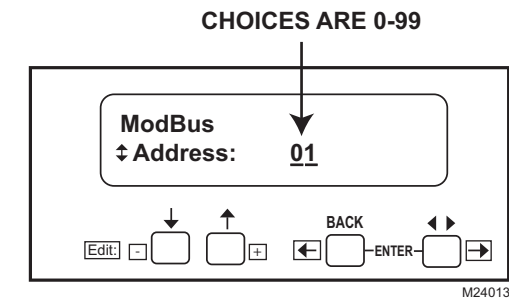
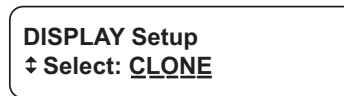

Fig. 29. Up/Down arrows increase or decrease number.

00 is the default, meaning ModBus is disabled.

01-99 are available addresses. Use terminal 1 and 2 on the 203541 connector for data + and data - connections.

Use ↑ and ↓ to select address. Press ENTER.

The left box blinking means ModBus activity is occurring. The right box blinking means this address is receiving activity (see Fig. 31). 00 is the default, meaning ModBus is disabled. 01-99 are available addresses. Use terminal 1 and 2 on the 203541 connector for data+ and data- connections (see Fig. 8).

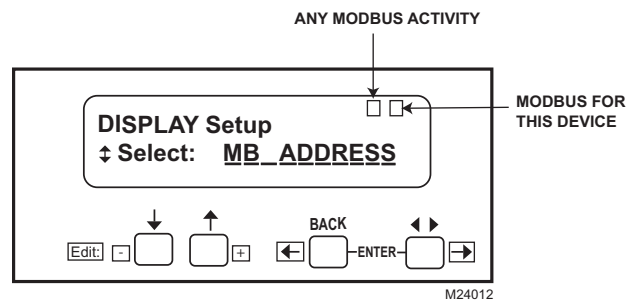

Fig. 31. ModBus activity as viewed on Setup screen.

Display Setup—MB Baud

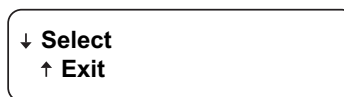

Fig. 32. Select/Exit screen.

Select: M B B A U D. Display Setup MB Baud by pressing ENTER.



Fig. 33. MB Baud entered on Select screen.

Press ↓ to select.

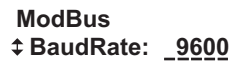

ModBus
↕ BaudRate: 9600

Fig. 34. ModBus Baud rate selection setup.

Use the ↑ and ↓ keys to change rates (choices are 9600, 19,200, and 38,400).



↓ – Save Changes
↑ – Exit no Save

Fig. 35. Save Changes/Exit No Save screen will display again.

Press ENTER at the Save Changes/Exit No Save screen.

The display will go back to the DISPLAY Setup/Select CLONE screen:



DISPLAY Setup
↕ Select: CLONE

Fig. 36. DISPLAY Setup/Select CLONE Screen.

Display Setup—Clear All

Clear All resets the display setting back to the factory settings.

To access the Display Setup Menu:

Press the left three buttons of the KDM for one second, then release. DISPLAY Setup will appear:



DISPLAY Setup
± PASSWORD: 000

Fig. 37. DISPLAY Setup screen.

Enter your password if it has been changed from the Default Password.

Press ENTER using the two ENTER buttons at the same time. The Select/Exit screen (see Fig. 33) will appear. Choose Select.



DISPLAY Setup
± Select: CLONE

Fig. 38. DISPLAY Setup/Select CLONE screen.

Press the down arrow to scroll to CLEAR ALL.

Press ENTER, using the two ENTER buttons at the same time to select. The Select/Exit screen (see Fig. 33) will appear. Choose Select.



Clear Configuration
Use ENTER to Confirm

Fig. 39. Clear Configuration screen.

Press ENTER using the two ENTER buttons at the same time.



↓ Clear ALL
↑ Exit

Fig. 40. Clear ALL screen.

Press the Down arrow Clear All.

All display settings are returned to the factory defaults.

Display will go back to the DISPLAY Setup/Select CLONE screen (see Fig. 38).

Display Setup—Password

The S78800A KDM, Series 4 or higher, requires a password to make changes to the display information, such as unique Call Service Message or Expanded Annunciator Message information, for example.

The display is programmed with a default password of 000 (three zeros) and can easily be changed to any three numbers.

NOTE: Use caution when selecting and securing your new password, should access be required in the future.

Re-entering the Display Setup will show different numbers and your unique password will need to be entered to gain access.

To access the Change Password menu.

Press the left three buttons of the KDM for one second, then release.

The DISPLAY Setup screen (see Fig. 37) will appear. Press ENTER using the two ENTER buttons at the same time.

The Select/Exit Screen (see Fig. 33) will appear. Choose Select.

The DISPLAY Setup/Select CLONE screen (see Fig. 23) will appear. Use the down arrow to scroll through the menu choices until PASSWORD appears.

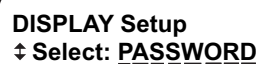

DISPLAY Setup
↕ Select: PASSWORD

Fig. 41. DISPLAY Setup/Select PASSWORD screen.

Press ENTER using the two ENTER buttons at the same time.



Fig. 42. Change Password/New Password screen.

Use up/down arrows to change the numbers and left/right arrows to move the cursor.

Press ENTER using the two ENTER buttons at the same time.



Fig. 43. Save Changes/Exit no Save screen.

Use down arrow to save.



Fig. 44. New Password Is screen.

The following message will appear:

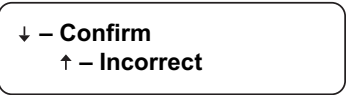

Fig. 45. Confirm/Incorrect screen.

Use arrow for your selection. Choosing Confirm will take you out of the DISPLAY Setup menu.

Press the left three buttons of the KDM for one second, then release.



Fig. 46. DISPLAY Setup/PASSWORD screen.

Use up/down arrows to change numbers and left/right arrows to move the cursor to enter your new password.

Press ENTER using the two ENTER buttons at the same time.

The Select/Exit Screen (see Fig. 33) will appear. Choose Select and you will be in the DISPLAY Setup menu. The DISPLAY Setup/Select PASSWORD screen (see Fig. 41) will appear. Press ENTER using the two ENTER buttons at the same time.

The Select/Exit Screen (see Fig. 33) will appear. Choose Exit and you will be out of the Setup menu again.

Display Setup—CS ON/OFF

CS ON/OFF allows the Call Service Message to be as follows:

- OFF—No call Service Message displayed, normal 7800 SERIES lockout message displayed.
- ON—Customized Call Service Message displayed on 7800 SERIES lockout. Goes away when 7800 SERIES reset button is pushed—just like a normal lockout.
- ON, Temporarily Off—Used for service technician to view normal 7800 SERIES Lockout messages along with diagnostic and history files. After 5 minutes, the display goes back to the Call Service On mode.

DISPLAY Setup will appear. Enter your password if you have changed the default password.

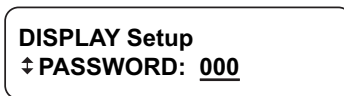

Fig. 47. DISPLAY Setup/PASSWORD screen.

Press ENTER using the two ENTER buttons at the same time.

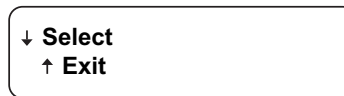

Fig. 48. Select/Exit screen.

Choose Select.

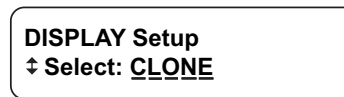

Fig. 49. DISPLAY Setup/Select CLONE screen.

Use the down arrow to scroll through the menu choices until CS ON/OFF appears.

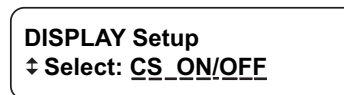

Fig. 50. DISPLAY Setup/Select: CS ON/OFF screen.

Press ENTER using the two ENTER buttons at the same time.

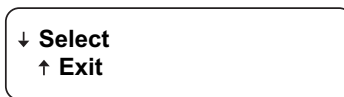

Fig. 51. Select/Exit screen.

Press Down arrow to Select.



Fig. 52. CS ON/OFF screen.

Use the up/down arrows to select (ON, OFF, or ON, Temporarily OFF).



Fig. 53. Save Changes/Exit no Save screen.

Use down arrow to Save.

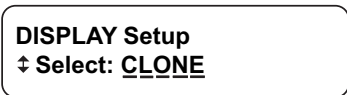

Fig. 54. DISPLAY Setup/Select CLONE screen.

Use up or down arrows to move to another selection. If ENTER is pressed, the following screen appears:



Fig. 55. Select/Exit screen.

Choose up arrow to exit to normal display function.

Display Setup—CS TEST

CS TEST allows the Call Service message to be viewed. Accuracy and appearance can be viewed without putting the 7800 SERIES into lockout.

To access the CS TEST menu:

Press the left three buttons of the KDM for one second, then release.

DISPLAY Setup will appear. If you have a personal password, enter it to enter setup.

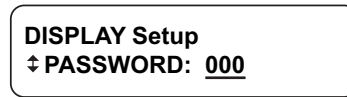

Fig. 56. DISPLAY Setup/PASSWORD screen.

Press ENTER by pressing the two ENTER buttons at the same time.



Fig. 57. Select/Exit screen.

Choose Select.

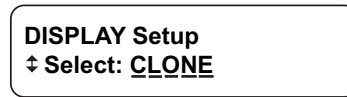

Fig. 58. DISPLAY Setup/Select CLONE screen.

Use the down arrow to scroll through menu choices until CS TEST appears.

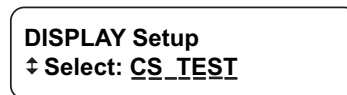

Fig. 59. DISPLAY Setup/Select CS TEST screen.

Press ENTER using the two ENTER buttons at the same time.

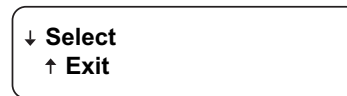

Fig. 60. Select/Exit screen.

Choose Select.

The display will sequence once through the Call Service message you have entered during the CS Edit setup.

Below is the default message.

Press ENTER using the two ENTER buttons at the same time to select.

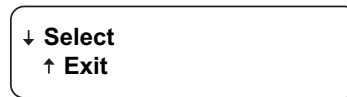

Fig. 61. Select/Exit screen.

Choose Select.

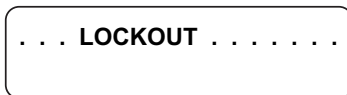

Fig. 62. LOCKOUT screen.

Displayed for two seconds.



Fig. 63. CALL SERVICE screen.



Fig. 64. Blank screen.

The blank screen is displayed for two seconds.

When done, the display will be:

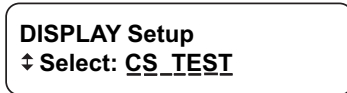

Fig. 65. DISPLAY Setup/Select CS TEST screen.

Press ENTER using the two ENTER buttons at the same time.



Fig. 66. Select/Exit screen.

Choose Exit.

You will be taken completely out of the Setup menu.

Display Setup—CS EDIT

CS EDIT allows customizing or personalizing a Call Service message. Three screens of messages are available. Each screen has two lines of text with 20 characters available. See Table 9 for available characters. This message will be displayed with the 7800 SERIES is in a lockout condition in place of the normal Lockout Fault condition. Note that the Call Service feature must be turned ON using the CS ON/OFF selection.

To access the CS EDIT menu:

Press the left three buttons of the KDM for one second, then release.

DISPLAY Setup will appear. If you have a personal password, enter it to enter Setup.

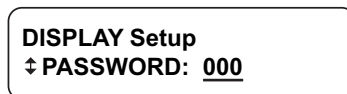

Fig. 67. DISPLAY Setup/PASSWORD screen.

Press ENTER by pressing the two ENTER buttons at the same time.



Fig. 68. Select/Exit screen.

Choose Select.

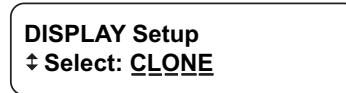

Fig. 69. DISPLAY Setup/Select CLONE screen.

Use the down arrow to scroll down through menu choices until CS EDIT appears.



Fig. 70. DISPLAY Setup/Select CS EDIT screen.

Press ENTER using the two ENTER buttons at the same time.

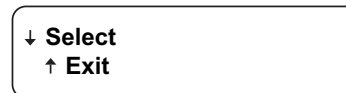

Fig. 71. Select/Exit screen.

Choose Select.

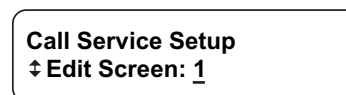

Fig. 72. Call Service Setup/Edit Screen 1 screen.

Press ENTER using the two ENTER buttons at the same time.



Fig. 73. Select/Exit screen.

Choose Select.



Fig. 74. LOCKOUT screen.

Using the left/right arrow will move the cursor left and right. Up and down arrows will move you through the series of available scripts (See Table 9). Up to 20 characters per line (you have two lines available) can be used in your message.

NOTE: Moving through the scripts:

1. Pressing and holding an up/down arrow will fast forward to the end of the current script.
2. A space is located between the capital and lower case alphabets.
3. A space is added if you move the cursor right when it is under an empty character position.

Pressing the ENTER keys will show:



Fig. 75. Save/Exit/Clear EOL screen.

Pressing the left arrow will clear text on the line you are on and return you to the CS Edit screen. When you have finished entering your description, press the ENTER keys.



Fig. 76. Save/Exit/Clear EOL screen.

Press the down arrow to Save.



Fig. 77. Call Service Setup screen.

Use the up arrow to go to screen 2 or 3. Repeat the above steps for custom messages you wish to create. When complete with your final message, press ENTER.



Fig. 78. Save/Exit/Clear EOL screen.

Use the up arrow to select Exit.

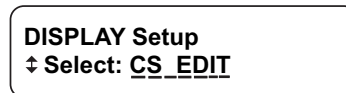

Fig. 79. DISPLAY Setup/Select CS EDIT screen.

Use the up arrow to scroll to CS TEST item to view your message. Return back to CS EDIT to make any corrections. Use the up arrow to scroll to CS ON/OFF to turn on your customer Call Service message.

Press ENTER, then Exit if you are finished.

APPENDIX B: EDIT TEXT AND CHARACTERS

Table 8. Edit Available Text and Characters.

		Edit Available Text and Characters			
A	a	(Space)	À	à	
B	b	?	Á	á	
C	c	!	Â	â	
D	d	"	Ã	ã	
		'			
E	e	-	Ä	ä	
F	f	:	Å	å	
G	g	&	É	é	
H	h	#	È	è	
I	i	(Ê	ê	
J	j)	Ë	ë	
K	k	*	Í	í	
L	l	+	Ì	ì	
M	m	.	Î	î	
N	n	,	Ï	ï	
O	o	/	Ó	ó	
P	p	0	Ò	ò	
Q	q	1	Ô	ô	
R	r	2	Õ	õ	
S	s	3	Ö	ö	
T	t	4	Ú	ú	
U	u	5	Û	û	
V	v	6	Û	û	
W	w	7	Ü	ü	
X	x	8	Ç	ç	
Y	y	9	Ñ	ñ	
Z	z		ÿ	ÿ	

APPENDIX C: MODBUS DATA FEATURES

See Appendix A page 25 for Setup.

OPERATION

The S7800 ModBus™ Data Feature enables terminal 1, 2 to Data + and Data -. Table 9 provides register mapping. It identifies the mapping of the 7800 SERIES parameters to ModBus™ registers.

Function Codes

Supported function codes of Modbus Protocol Reference Guide (PI-MBUS-300 Rev. J) are 3, 4, 6, and 17. Function codes 3 and 4 are treated the same by the S7800. Two registers need to be read when the data format is a U32 value (4 bytes); if both registers are not read, then a data value of 0 (zero) is returned. U32 values are in little endian format. The maximum number of addresses that can be queried is 127 (0x7F) for each query message.

Tables 3 through 7 provide information on the function codes.

NOTE: All Query and Response cells below are 1 byte.

Table 9. Query Message Format for Function Codes 3 and 4.

Slave Address	Function Code	Starting Address High	Starting Address Low	Number of Addresses High	Number of Addresses Low	CRC	CRC
01	03	00	0A	00	01	A4	08

Table 10. Response Message Format for Function Codes 3 and 4.

Slave Address	Function Code	Byte Count	Data High	Data Low	CRC	CRC
01	03	02	00	22	38	5D

Table 11. Query Message Format for Function Code 6 (Broadcast is supported by using a slave address of 00).

Slave Address	Function Code	Starting Address High	Starting Address Low	Preset Data High	Preset Data Low	CRC	CRC
01	06	00	7F	00	04	B9	D1

Table 12. Response Message Format for Function Code 6 (There is no response if the query was broadcast.)

Slave Address	Function Code	Starting Address High	Starting Address Low	Preset Data High	Preset Data Low	CRC	CRC
01	06	00	7F	00	04	B9	D1

Table 13. Query Message Format for Function Code 17.

Slave Address	Function Code	CRC	CRC
03	11	C1	4C

NOTE: See Table 18 for function code 17 response format.

Table 14. Exception Response Message Format.

Slave Address	Function Code + 80h	Exception Code	CRC	CRC

Table 15. Exception Codes.

Exception Code	Definition	Description
01	Illegal Function	An illegal function as requested. Only 3, 4, 6 and 17 are supported.
02	Illegal Data Address	Too many bytes requested, address is out of range, register is read only, or the number of address requested is past the last register.
03	Illegal Data Value	The "Preset Data" from function code 6 is invalid/out of range.

Device Address and Baud Rate

Assign each device in the system a unique address by setting the MODBUS ADDRESS (see page 26). Only RTU communications with 1 Start Bit, 8 Data Bits, 1 Stop Bit and no parity is supported.

NOTE: Assign a device address number from 01 to 99. 00 is not an acceptable address number and will not work, except for the broadcast ability of function 6.

NOTE: In Tables 10, 15 and 18: Line 1 and Line 2 refer to the two lines of text on the S7800 Keyboard Display Module. In Tables 21, 23 and 24: The String Code column references Table 21, String Codes. In Table 22: The Burner Control State Bits column references Table 21, Burner Control State Bits..

Table 16. ModBus™ Register Assignments.

Address (hex)	Register (dec)	Parameter Name	Read/Write	Format	Notes
0000	40001	Burner Control (BC) Fault Code	R	U16	See Table 22. Non-zero value = Lockout number.
0001	40002	BC Fault String Code	R	U16	See Table 21. Lockout text.
0002	40003	BC Sequence State	R	U16	See Table 22 (valid only if Fault code = 0).
0003	40004	BC State String Code (line 1)	R	U16	See Table 21. Simulates Line 1 of S7800.
0004	40005	BC State String Code (line 2)	R	U16	See Table 21. Simulates Line 2 of S7800.
0005	40006	BC Sequence time	R	U16	0-4095 Seconds.
0006	40007	BC Total cycles	R	U32	Max value is 0xFFFFFFFF.
0008	40009	BC Total hours	R	U32	Max value is 0xFFFFFFFF.
000A	40011	BC Flame 1 signal strength	R	U16	0 to 255 represents 0.0 to 25.5 volts. Not clipped to 5.0V like S7800.
000B	40012	BC Flame 2 signal strength	R	U16	0 to 4095. N/A for 7800 SERIES.
000C	40013	BC State Bits	R	U16	See Table 19.
000D	40014	Unused			
000E	40015	Unused			
0010-0019	40017-40026	BC Fault history record 1	R		Newest fault record. See Table 23.
001A-0023	40027-40036	BC Fault history record 2	R		Second newest fault record. See Table 23.
0024-002D	40037-40046	BC Fault history record 3	R		Third newest fault record. See Table 23.
002E-0037	40047-40056	BC Fault history record 4	R		Fourth newest fault record. See Table 23.
0038-0041	40057-40066	BC Fault history record 5	R		Fifth newest fault record. See Table 23.
0042-004B	40067-40076	BC Fault history record 6	R		Oldest fault record. See Table 23.
004C	40077	BC Flame Failure Response Time	R	U16	Tenths of Seconds.
004D	40078	BC Manufacturing code	R	U32	
004F	40080	BC Type Code	R	U16	See Table 18.
0050	40081	SS7800/BC Software version	R	U32	
0052	40083	Unused			
0054	40085	BC Remote Command status.	R	U16	Bit 0: Autonomous. Bit 1: Remote commanded off. Bit 2: Remote commanded High fire. Bit 3: Remote commanded low fire. Bit 4: Remote reset has/will be sent to BC. ^a Bits 5-14: Unused. Bit 15: Copied after the most recent write to the burner control command (40128 bit 15).
0055	40086	BC Flame Amplifier type	R	U16	0 = Standard 1 = Unknown 2 = Amplicheck or missing amplifier 3 = Shutter
0056	40087	BC Purge Time	R	U16	Seconds
0057-0065	40088-40102	BC Diagnostics	R	U16	String codes indicating terminal/jumper state. See Table 20. There are up to 15 codes. Not all are used for some burner controls.

Table 16. ModBus™ Register Assignments. (Continued)

Address (hex)	Register (dec)	Parameter Name	Read/Write	Format	Notes														
0066	40103	Post-Purge time	R	U16	Seconds														
0067	40104	Valve Proving Mode	R	U16	0 = Valve Proving is not enabled 1 = Enabled before Run 2 = Enabled after Run 3 = Enabled before and after Run 4 = Enabled split half before and half after Run														
0068	40105	Valve Proving options	R	U16	1 = Uncommissioned 2 = Commissioned														
0069	40106	Valve Proving time	R	U16	Seconds														
0066-007E	40103-40127	Unused																	
007F	40128	BC Remote Command	R/W	U16	Only one bit in the LSByte must be set, with the exception of bit 15: Bit 0 =Revert to autonomous operation. Bit 1 = Don't fire, remain off. Bit 2 = Go to Hi Fire during Run. Bit 3 = Go to Lo Fire during Run. Bit 4 = Remote reset. ^a Bits 5-7 must be 0. Bits 8-14 are ignored. Bit 15: Copied to the control status register. The remote control status register can be used to verify operation of the command. Bits 1-3 must be refreshed at least every 120 seconds, but not more than once a second, for the burner control to remain in the commanded state.														
01B7-01B8	40440-40441	Unused		U32															
01BA	40443	Device Data Ready		U16	Device data was properly received by S7800. <table border="0"> <tr> <td><u>Bit(s)</u></td> <td><u>Device</u></td> </tr> <tr> <td>0</td> <td>RM78XX</td> </tr> <tr> <td>3</td> <td>EC78XX</td> </tr> <tr> <td>4-15</td> <td>Unused</td> </tr> </table>	<u>Bit(s)</u>	<u>Device</u>	0	RM78XX	3	EC78XX	4-15	Unused						
<u>Bit(s)</u>	<u>Device</u>																		
0	RM78XX																		
3	EC78XX																		
4-15	Unused																		
01BB	40444	S7800 Device Compatibility with Current Software Revision S7800 Software Revision Compatibility with Legacy Software Revisions.		U16	Device is compatible with the S7800 version. <table border="0"> <tr> <td><u>Bit</u></td> <td><u>Device</u></td> </tr> <tr> <td>0</td> <td>RM78XX</td> </tr> <tr> <td>3</td> <td>EC78XX</td> </tr> <tr> <td>4-7</td> <td>Unused</td> </tr> </table> Used for indication of S7800 revision compatibility. <table border="0"> <tr> <td><u>Bit(s)</u></td> <td><u>Compatible with:</u></td> </tr> <tr> <td>8</td> <td>Series 2</td> </tr> <tr> <td>9-15</td> <td>Future</td> </tr> </table>	<u>Bit</u>	<u>Device</u>	0	RM78XX	3	EC78XX	4-7	Unused	<u>Bit(s)</u>	<u>Compatible with:</u>	8	Series 2	9-15	Future
<u>Bit</u>	<u>Device</u>																		
0	RM78XX																		
3	EC78XX																		
4-7	Unused																		
<u>Bit(s)</u>	<u>Compatible with:</u>																		
8	Series 2																		
9-15	Future																		

NOTE: "Device Data Ready" and "S7800 Compatibility" bits can be used to quickly check device availability and compatibility then read/write registers of only these devices.

Response Message Format for Function Code 17.

This format is device specific and is only available for the 7800 SERIES burner control. See Table 17.

Table 17. Response Message Format for function code 17 (11h), (26 bytes).

	Slave Address	Function Code	Byte Count	Slave ID ^a	Run Indicator Status ^b	Device Description ^c	N/A	CRC	CRC
Byte	0	1	2	3	4	5-15	16-23	24	25

^a Slave ID: Always 0x78 when using RM78xx or EC78xx Relay Modules(1 byte) (byte 3).

^b Run Indicator Status: Always FF=ON (one byte) (byte 4).

^c Device Description: 16 Character ASCII OS number for the Burner Control (11 bytes) (bytes 5-15).

Burner Control Type Codes

The burner control type code indicates the exact model number of the burner control. See Table 18.

Table 18. Burner Control Type Codes.

CODE	DEVICE DESCRIPTION
0	(undefined)
100	RM7800E
101	RM7800G
102	RM7800L
103	RM7800M
104	RM7838A
105	RM7838B
106	RM7840E
107	RM7840G
108	RM7840L
109	RM7840M
110	RM7885A
111	RM7888A
112	RM7890A
113	RM7895A
114	RM7895B
115	RM7823A
116	RM7824A
117	RM7830A
118	RM8738C
119	RM7845A
120	RM7850A
121	RM7865A
122	RM7865B
123	RM7865C
123	RM7890B
124	RM7890B
125	RM7890C
126	RM7890D
127	RM7895C
128	RM7895D
129	RM7895E
130	RM7895F
131	RM7896A
132	RM7896B
133	RM7896C
134	RM7896D

CODE	DEVICE DESCRIPTION
135	RM7897A
136	RM7897C
137	RM7898A
138	R7140G
139	R7140L
140	R7140M
199	RM78xx
200	EC7810A
201	EC7820A
202	EC7830A
203	EC7850A
204	EC7885A
205	EC7890A
206	EC7895A
207	EC7895C
208	EC7823A
209	EC7840L
210	EC7865
299	EC78xx

7800 SERIES Burner Control State Bits

The burner control sequence state is translated into State Bit Register as shown in Table 19.

Table 19. Burner Control State Bits.

BIT	Description	BC State Bits Register
0	Initiate	0000 0000 0000 0001
1	Standby	0000 0000 0000 0010
2	Purge	0000 0000 0000 0100
3	Pilot Ignition	0000 0000 0000 1000
4	Main Ignition	0000 0000 0001 0000
5	Run	0000 0000 0010 0000
6	Postpurge	0000 0000 0100 0000
7	Pre-Ignition	0000 0000 1000 0000
8	Valve Proving	0000 0001 0000 0000
13	Alarm	1010 0000 xxxx xxxx NOTE: Lockout bit is also set.
14	Hold	0100 0000 xxxx xxxx One other bit may be on.
15	Lockout	1010 0000 0000 0000 NOTE: Alarm bit is also set.

7800 SERIES Sequence State Codes

Sequence state codes are provided by the Burner Control. Each code is translated into two string codes for displaying an associated message in two lines. Each code is also translated into burner control state bits which may be used to generate and control system diagrams on an operator interface. The codes can also be retrieved from registers 40004, 40005, and 40013.

The Sequence State Codes shown in Table 20 are valid only if the Fault Code has a value of zero. If the Fault Code is non-zero, the sequence state field contains the sequence state code when the lockout occurred.

Table 20. 7800 SERIES Sequence State Codes and Associated register code values.

Register 40003	7800 SERIES Sequence State	String Code		Uses mm:ss	Burner Control State Bits
		Line 1	Line 2		
Fault code not zero	LOCKOUT	52	Table 16		8000h
0	UNUSED HISTORY	0	0		0000h
1	INITIATE	48	0	✓	0001h
2	INITIATE HOLD: AC FREQUENCY/ NOISE	49	8		4001h
3	INITIATE HOLD: AC LINE DROPOUT	49	9		4001h
4	INITIATE HOLD: AC FREQUENCY	49	7		4001h
5	INITIATE HOLD: LOW LINE VOLTAGE	49	60		4001h
6	STANDBY	103	0		0002h
7	STANDBY HOLD: REM REMOTE CONTROL	104	94		4002h
8	STANDBY HOLD: START SWITCH	104	106		4002h
9	STANDBY HOLD: F/G FLAME DETECTED	104	35		4002h
10	STANDBY HOLD: T20 PRE-IGNITION	104	86		4002h
11	STANDBY HOLD: T7 RUNNING INTERLOCK	104	101		4002h
12	STANDBY HOLD: T7 LOCKOUT INTERLOCK	104	54		4002h
13	STANDBY HOLD: AIRFLOW SWITCH	104	13		4002h
14	PURGE HOLD: T19 HIGH FIRE SWITCH	93	40		4004h
15	PURGE DELAY:T19 HIGH FIRE JUMPRD	89	39		4004h

Table 20. 7800 SERIES Sequence State Codes and Associated register code values. (Continued)

Register 40003	7800 SERIES Sequence State	String Code		Uses mm:ss	Burner Control State Bits
		Line 1	Line 2		
16	PURGE HOLD: TEST RUN/TEST SWITCH	93	98		4004h
17	PURGE DELAY: T18 LOW FIRE JUMPRD	89	56		4004h
18	PURGE HOLD: F/G FLAME DETECTED	93	35		4004h
19	PURGE	87	0	✓	0004h
20	PURGE HOLD: T18 LOW FIRE SWITCH	93	58		4004h
21	PURGE HOLD: T7 Running Interlock	93	101		4004h
22	PURGE HOLD: LOCKOUT INTERLOCK	93	54		4004h
23	PURGE HOLD: AIRFLOW SWITCH	93	13		4004h
24	PURGE HOLD: START SWITCH	93	106		4004h
25	PILOT IGN	78	0	✓	0008h
26	PILOT HOLD: TEST RUN/TEST SWITCH	77	98		4008h
27	PILOT HOLD: START SWITCH	77	106		4008h
28	MAIN IGN	66	0	✓	0010h
29	MAIN IG HOLD: MANUAL-OPEN SWITCH	67	72		4010h
30	RUN	95	0		0020h
31	RUN PV HOLD: LOW FIRE SWITCH	96	58		4020h
32	PVHOLD IGN	77	46	✓	4008h
33	PV HOLD: PV HOLD SWITCH	77	45		4008h
34	RUN/LOWFIRE: TEST RUN/TEST SWITCH	97	98		4020h
35	POSTPURGE	83	0	✓	0040h
36	STATE UNKNOWN	31	0		0000h
37	RESET/ALARM TEST	111	0		6000h
38	SAFETY START	102	105		4002h
39	SAFETY1-1	102	2	✓	0008h
40	SAFETY1-2	102	3	✓	0008h
41	SAFETY1-3	102	4	✓	0008h
42	SAFETY1-4	102	5	✓	0008h
43	SAFETY1-5	102	6	✓	0008h
44	Blank	0	0		A000h
45	PRE-IGNITION	84	0	✓	0008h

Table 20. 7800 SERIES Sequence State Codes and Associated register code values. (Continued)

Register 40003	7800 SERIES Sequence State	String Code		Uses mm:ss	Burner Control State Bits
		Line 1	Line 2		
46	SAFETY 1	102	1	✓	0008h
47	PILOT STAB.	79	0		0008h
48	MAIN TRIAL	68	0	✓	0010h
49	MAIN TRIAL	68	0		0010h
50	STANDBY HOLD: RUN/TEST SWITCH	104	98		4002h
51	STATE 51	31	0		A000h
52	STATE 52	31	0		A000h
53	SAFETY 1: RUN/TEST SWITCH	102	98		4008h
54	STATE 54	31	0		A000h
55	STANDBY HOLD: PURGE FAN SWITCH	104	92		4002h
56	STATE 56	31	0		A000h
57	PURGE HOLD: PURGE FAN SWITCH	93	92		4004h
58	STANDBY HOLD FLAME DETECTED	104	35		4002h
59	STANDBY HOLD COMB. PRESSURE	104	26		4002h
60	VP START	210	0	✓	4100h
61	VP MV2 ON	211	0	✓	4100h
62	VP LOW DLY	212	0	✓	4100h
63	VP LOW TST	213	0	✓	4100h
64	VP MV1 ON	214	0	✓	4100h
65	VP HIGH DLY	215	0	✓	4100h
66	VP HIGH TST	216	0	✓	4100h
67	INITIATE HOLD: AC AC PHASE ERROR	49	10		4001h
68	STANDBY HOLD: PRE-IGNITION ILK	104	85		4002h
69	SETUP NEEDED	217	0		A000h
70	STATE 70	31	0		A000h
71	BURNER OFF: T6 BURNER SWITCH	22	23		4002h
72	STANDBY HOLD: (EA) HOLD MSG	184	30		4002h
73	STANDBY HOLD: (EA) CIRCUIT FAULT	184	25		4002h
74	STANDBY HOLD (EA)	184	Varies		4002h
75	PURGE HOLD (EA)	185	Varies		4004h
76	UNUSED	0			0h
77	UNUSED	0			0h
78	UNUSED	0			0h

Table 20. 7800 SERIES Sequence State Codes and Associated register code values. (Continued)

Register 40003	7800 SERIES Sequence State	String Code		Uses mm:ss	Burner Control State Bits
		Line 1	Line 2		
79	UNUSED	0			0h
80	UNUSED	0			0h
81	STANDBY HOLD (EA): VALVE CLOSURE	184	109		4002h
82	STANDBY HOLD (EA) OTHER PII	184	75		4002h

7800 SERIES String Codes

Table 21 contains a listing of all string codes provided by the S7800. The associated string is not implemented in the S7800; it is a string equivalent to that displayed on the S7800 Keyboard Display Module or similar device.

Table 21. 7800 SERIES String codes.

String Code	String
0	(blank)
1	1
2	1-1
3	1-2
4	1-3
5	1-4
6	1-5
7	AC FREQUENCY
8	AC Frequency/Noise
9	AC LINE DROPOUT
10	AC PHASE
11	ACCESSORY FAULT
12	AIRFLOW SW. ON
13	AIRFLOW SWITCH
14	ATOMIZING SW
15	AUX INTERLOCK #4
16	AUX INTERLOCK #5
17	AUX LIMIT #1
18	AUX LIMIT #2
19	AUX LIMIT #3
20	BLOCK INTAKE
21	BOTH FUELS SELECT
22	BURNER OFF
23	BURNER SWITCH
24	CALL SERVICE
25	CIRCUIT FAULT
26	COMB. PRESSURE
27	CONTROL ON
28	DELAYED MV ON
29	DEVICE SPECIFIC

Table 21. 7800 SERIES String codes. (Continued)

String Code	String
30	EA HOLD MESSAGES
31	UNKNOWN STATE
32	FLAME AMP TYPE
33	FLAME AMP/SHUTR
34	FLAME AMPLIFIER
35	FLAME DETECTED
36	FLAME TOO STRONG
37	FLAME-OUT TIMER
38	FUEL SELECT OFF
39	HIGH FIRE JUMPERED
40	HIGH FIRE SWITCH
41	HIGH GAS PRESSURE
42	HIGH LIMIT
43	HIGH OIL PRESSURE
44	HIGH OIL TEMP
45	HOLD SWITCH
46	IGNITION
47	IGNITION ON
48	INITIATE
49	INITIATE HOLD
50	JUMPERS CHANGED
51	JUMPERS WRONG
52	LOCKOUT
53	LOCKOUT ILK ON
54	LOCKOUT INTERLOCK
55	LOCKOUT SWITCH
56	LOW FIRE JUMPERED
57	LOW FIRE SW OFF
58	LOW FIRE SWITCH
59	LOW GAS PRESSURE
60	LOW LINE VOLTAGE
61	LOW OIL PRESSURE
62	LOW OIL TEMP
63	LWCO
64	MAIN FLAME FAIL
65	MAIN FLAME IGN.
66	MAIN IGN
67	MAIN IGN HOLD
68	MAIN TRIAL
69	MAIN VALVE ON
70	MAN-OPEN SW. OFF
71	MAN-OPEN SW. ON
72	MAN-OPEN SW.
73	NO PURGE CARD
74	OTHER INTERLOCKS
75	OTHER PREIGN ILK
76	PILOT FLAME FAIL

Table 21. 7800 SERIES String codes. (Continued)

String Code	String
77	PILOT HOLD
78	PILOT IGN
79	PILOT STABILIZE
80	PILOT VALVE 1 ON
81	PILOT VALVE 2 ON
82	POOR FLAME SENSOR
83	POSTPURGE
84	PRE-IGNITION
85	PRE-IGNITION ILK
86	PRE-IGNITION
87	PURGE
88	PURGE CARD ERROR
89	PURGE DELAY
90	PURGE FAN SW OFF
91	PURGE FAN SW ON
92	PURGE FAN SWITCH
93	PURGE HOLD
94	REMOTE CONTROL
95	RUN
96	RUN HOLD
97	RUN/LOWFIRE
98	RUn/TEST SWITCH
99	RUNNING ILK
100	RUNNING ILK ON
101	RUNNING INTERLOCK
102	SAFETY
103	STANDBY
104	STANDBY HOLD
105	START
106	START SWITCH
107	START SWITCH ON
108	TEST STATE
109	VALVE CLOSURE
110	ALL SWITCHES ON
111	RESET/ALARM TEST
112	Run/Test Switch RUN
113	Run/Test Switch TEST
114	Operator Control T6 = 0
115	Operator Control T6 = 1
116	Interlock T7 = 0
117	Interlock T7 = 1
118	Airflow Interlock T7 = 0
119	Airflow Interlock T7 = 1
120	Block Intake T7 = 0
121	Block Intake T7 = 1
122	Valve T8 = 0
123	Valve T8 = 1

Table 21. 7800 SERIES String codes. (Continued)

String Code	String
124	Intrptd PV T8 = 0
125	Intrptd PV T8 = 1
126	Main Valve T9 = 0
127	Main Valve T9 = 1
128	Ignition T10 = 0
129	Ignition T10 = 1
130	PV Hold T16 = 0
131	PV Hold T16 = 1
132	Input A T16 = 0
133	Input A T16 = 1
134	ManOpenSw T17 = 0
135	ManOpenSw T17 = 1
136	Input B T17 = 0
137	Input B T17 = 1
138	Prelgn ILK T17 = 0
139	Prelgn ILK T17 = 1
140	LowFire Sw T18 = 0
141	LowFire Sw T18 = 1
142	Purge Fan T18 = 0
143	Purge Fan T18 = 1
144	HighFire Sw T19 = 0
145	HighFire Sw T19 = 1
146	Prelgn ILK T20 = 0
147	Prelgn ILK T20 = 1
148	Lockout Inp T20 = 0
149	Lockout Inp T20 = 1
150	Comb Press T20 = 0
151	Comb Press T20 = 1
152	Valv/Start T21 = 0
153	Valv/Start T21 = 1
154	Intmitt PV T21 = 0
155	Intmitt PV T21 = 1
156	Terminal T6 = 0
157	Terminal T6 = 1
158	Terminal T7 = 0
159	Terminal T7 = 1
160	Terminal T8 = 0
161	Terminal T8 = 1
162	Terminal T9 = 0
163	Terminal T9 = 1
164	Terminal T10 = 0
165	Terminal T10 = 1
166	Terminal T16 = 0
167	Terminal T16 = 1
168	Terminal T17 = 0
169	Terminal T17 = 1
170	Terminal T18 = 0

Table 21. 7800 SERIES String codes. (Continued)

String Code	String
171	Terminal T18 = 1
172	Terminal T19 = 0
173	Terminal T19 = 1
174	Terminal T20 = 0
175	Terminal T20 = 1
176	Terminal T21 = 0
177	Terminal T21 = 1
178	Jumper 1 Intact
179	Jumper 1 Clipped
180	Jumper 2 Intact
181	Jumper 2 Clipped
182	Jumper 3 Intact
183	Jumper 3 Clipped)
NOTE:	The values that follow are generated when the fault code is zero and the Expanded Annunciator code indicates that one or more switches are open. The Line 2 string code will indicate which switch is open.
184	STANDBY HOLD (EA)
185	PURGE HOLD (EA)
186	PILOT HOLD (EA)
187	MAIN IG HOLD (EA)
188	RUN HOLD (EA)
189	POSTPURGE HOLD (EA)
190	PRE-IGNITION HOLD (EA)
191	-SKIPPED-
192	DEMAND T6 = 0
193	DEMAND T6 = 1
194	PILOT VALVE T8 = 0
195	PILOT VALVE T8 = 1
196	INTERMIT PV T8 = 0
197	INTERMIT PV T8 = 1
198	MAIN VALVE1 T9 = 0
199	MAIN VALVE1 T9 = 1
200	VP SWITCH T16 = 0
201	VP SWITCH T16 = 1
202	MAIN VALVE2 T17 = 0
203	MAIN VALVE2 T17 = 1
204	INTRUPTD PV T21 = 0
205	INTRUPTD PV T21 = 1
206	DELAYED MV T21 = 0
207	DELAYED MV T21 = 1
208	START SW T21 = 0
209	START SW T21 = 1
210	VP START
211	VP MV2 ON
212	VP LOW DLY
213	VP LOW TST
214	VP MV1 ON

Table 21. 7800 SERIES String codes. (Continued)

String Code	String
215	VP HIGH DLY
216	VP HIGH TST
217	VP SETUP NEEDED
218	MAIN VALVE 1 OFF
219	MAIN VALVE 2 OFF
220	MAIN VALVE 1 ON
221	MAIN VALVE 2 ON
222	VPS OFF
223	VPS ON

7800 SERIES Fault Codes

Table 22 is a complete list of fault codes that may appear in the fault code register. The Fault String Code register will contain the corresponding String code identified in the table.

Table 22. 7800 SERIES Fault Codes.

Fault Code (Reg 40001)	Fault Message (NOTE: FAULT n: is not in the Fault and Strings Code)	Fault String Code (Table 22)
0	Blank (no fault)	0
1	FAULT 1: NO PURGE CARD	73
2	FAULT 2: AC FREQUENY/NOISE	8
3	FAULT 3: AC LINE DROPOUT	9
4	FAULT 4: AC FREQUENCY	7
5	FAULT 5: LOW LINE VOLTAGE	60
6	FAULT 6: PURGE CARD ERROR	88
7	FAULT 7: FLAME AMPLIFIER	34
8	FAULT 8: FLAME AMP/SHUTR	33
9	FAULT 9: FLAME DETECTED	35
10	FAULT 10: PRE-IGNITION ILK	85
11	FAULT 11: RUNNING ILK ON	100
12	FAULT 12: LOCKOUT ILK ON	53
13	FAULT 13: AIRFLOW SW. ON	12
14	FAULT 14: HIGH FIRE SWITCH	40
15	FAULT 15: FLAME DETECTED	35
16	FAULT 16: FLAME-OUT TIMER	37
17	FAULT 17: MAIN FLAME FAIL	64
18	FAULT 18: FLAME DETECTED	35
19	FAULT 19: MAIN FLAME IGN.	65
20	FAULT 20: LOW FIRE SW OFF	57
21	FAULT 21: RUNNING ILK	99
22	FAULT 22: LOCKOUT ILK	54
23	FAULT 23: AIRFLOW SWITCH	13
24	FAULT 24: CALL SERVICE	24
25	FAULT 25: CALL SERVICE	24
26	FAULT 26: MAN-OPEN SW. OFF	70
27	FAULT 27: START SWITCH ON	107
28	FAULT 28: PILOT FLAME FAIL	76

Table 22. 7800 SERIES Fault Codes. (Continued)

Fault Code (Reg 40001)	Fault Message (NOTE: FAULT n: is not in the Fault and Strings Code)	Fault String Code (Table 22)
29	FAULT 29: LOCKOUT ILK	54
30	FAULT 30: RUNNING ILK	101
31	FAULT 31: LOW FIRE SW OFF	57
32	FAULT 32: AIRFLOW SWITCH	13
33	FAULT 33: PRE-IGNITION ILK	85
34	FAULT 34: CONTROL ON	27
35	FAULT 35: CALL SERVICE	24
36	FAULT 36: CALL SERVICE	24
37	FAULT 37: CALL SERVICE	24
38	FAULT 38: CALL SERVICE	24
39	FAULT 39: CALL SERVICE	24
40	FAULT 40: CALL SERVICE	24
41	FAULT 41: MAIN VALVE ON	69
42	FAULT 42: PILOT VALVE 1 ON	80
43	FAULT 43: IGNITION ON	47
44	FAULT 44: PILOT VALVE 2 ON	81
45	FAULT 45: LOW FIRE SW OFF	57
46	FAULT 46: FLAME AMP TYPE	32
47	FAULT 47: JUMPERS CHANGED	50
48	FAULT 48: DELAYED MV ON	28
49	FAULT 49: MAN-OPEN SW. ON	71
50	FAULT 50: JUMPERS WRONG	51
51	FAULT 51: FLAME TOO STRONG	36
52	FAULT 52: CALL SERVICE	24
53	FAULT 53: LOCKOUT SWITCH	55
54	FAULT 54: COMB. PRESSURE	26
55	FAULT 55: PURGE FAN SW ON	91
56	FAULT 56: BLOCK INTAKE	20
57	FAULT 57: PURGE FAN SW OFF	90
58	FAULT 58: COMB. PRESS/FLAME	26
59	FAULT 59: CALL SERVICE	24
60	FAULT 60: CALL SERVICE	24
61	FAULT 61: MV1 OFF	218
62	FAULT 62: MV2 OFF	219
63	FAULT 63: MV1 ON	220
64	FAULT 64: MV2 ON	221
65	FAULT 65: VPS OFF	222
66	FAULT 66: VPS ON	223
67	FAULT 67: AC PHASE	10
68	FAULT 68: PRE-IGNITION ILK	85
69	FAULT 69: CALL SERVICE	24
70	FAULT 70: CALL SERVICE	24
71-75	FAULT 71-75: DEVICE SPECIFIC	29
76-93	FAULT 76-93: ACCESSORY FAULT	11
94-127	FAULT 94-127: CALL SERVICE	24

Table 22. 7800 SERIES Fault Codes. (Continued)

Fault Code (Reg 40001)	Fault Message (NOTE: FAULT n: is not in the Fault and Strings Code)	Fault String Code (Table 22)
128	FAULT 128: POOR FLAME SENSOR	82
129–141	FAULT 129-141: CALL SERVICE	24
142	FAULT 68z: OTHER PREIGN ILK ^{EA}	75
143	FAULT 68y: VALVE CLOSURE	109
144	FAULT 33z: OTHER PREIGN ILK ^{EA}	75
145	FAULT 33y: VALVE CLOSURE ^{EA}	109
146	FAULT 32s: OTHER INTERLOCKS ^{EA}	74
147	FAULT 32r: AUX INTERLOCK #5 ^{EA}	16
148	FAULT 32q: AUX INTERLOCK #4 ^{EA}	15
149	FAULT 32p: AIRFLOW SWITCH ^{EA}	13
150	FAULT 32o: LOW GAS PRESSURE ^{EA}	59
151	FAULT 32n: HIGH GAS PRESSURE ^{EA}	41
152	FAULT 32m: ATOMIZING SW ^{EA}	14
153	FAULT 32k: LOW OIL TEMP ^{EA}	62
154	FAULT 32j: HIGH OIL TEMP ^{EA}	44
155	FAULT 32i: LOW OIL PRESSURE ^{EA}	61
156	FAULT 32h: HIGH OIL PRESSURE ^{EA}	43
157	FAULT 32g: BOTH FUELS SELECT ^{EA}	21
158	FAULT 32f: FUEL SELECT OFF ^{EA}	38
159	FAULT 32e: AUX LIMIT #3 ^{EA}	19
160	FAULT 32d: HIGH LIMIT ^{EA}	42
161	FAULT 32c: LWCO ^{EA}	63
162	FAULT 32b: AUX LIMIT #2 ^{EA}	18
163	FAULT 32a: AUX LIMIT #1 ^{EA}	17
164	FAULT 30s: OTHER INTERLOCKS ^{EA}	74
165	FAULT 30r: AUX INTERLOCK #5 ^{EA}	16
166	FAULT 30q: AUX INTERLOCK #4 ^{EA}	15
167	FAULT 30p: AIRFLOW SWITCH ^{EA}	13
168	FAULT 30o: LOW GAS PRESSURE ^{EA}	59
169	FAULT 30n: HIGH GAS PRESSURE ^{EA}	41
170	FAULT 30m: ATOMIZING SW ^{EA}	14
171	FAULT 30k: LOW OIL TEMP ^{EA}	62
172	FAULT 30j: HIGH OIL TEMP ^{EA}	44
173	FAULT 30i: LOW OIL PRESSURE ^{EA}	61
174	FAULT 30h: HIGH OIL PRESSURE ^{EA}	43
175	FAULT 30g: BOTH FUELS SELECT ^{EA}	21
176	FAULT 30f: FUEL SELECT OFF ^{EA}	38
177	FAULT 30e: AUX LIMIT #3 ^{EA}	19

Table 22. 7800 SERIES Fault Codes. (Continued)

Fault Code (Reg 40001)	Fault Message (NOTE: FAULT n: is not in the Fault and Strings Code)	Fault String Code (Table 22)
178	FAULT 30d: HIGH LIMIT ^{EA}	42
179	FAULT 30c: LWCO ^{EA}	63
180	FAULT 30b: AUX LIMIT #2 ^{EA}	18
181	FAULT 30a: AUX LIMIT #1 ^{EA}	17
182	FAULT 29s: OTHER INTERLOCKS ^{EA}	74
183	FAULT 29r: AUX INTERLOCK #5 ^{EA}	16
184	FAULT 29q: AUX INTERLOCK #4 ^{EA}	15
185	FAULT 29p: AIRFLOW SWITCH ^{EA}	13
186	FAULT 29o: LOW GAS PRESSURE ^{EA}	59
187	FAULT 29n: HIGH GAS PRESSURE ^{EA}	41
188	FAULT 29m: ATOMIZING SW ^{EA}	14
189	FAULT 29k: LOW OIL TEMP ^{EA}	62
190	FAULT 29j: HIGH OIL TEMP ^{EA}	44
191	FAULT 29i: LOW OIL PRESSURE ^{EA}	61
192	FAULT 29h: HIGH OIL PRESSURE ^{EA}	43
193	FAULT 29g: BOTH FUELS SELECT ^{EA}	21
194	FAULT 29f: FUEL SELECT OFF ^{EA}	38
195	FAULT 29e: AUX LIMIT #3 ^{EA}	19
196	FAULT 29d: HIGH LIMIT ^{EA}	42
197	FAULT 29c: LWCO ^{EA}	63
198	FAULT 29b: AUX LIMIT #2 ^{EA}	18
199	FAULT 29a: AUX LIMIT #1 ^{EA}	17
200	FAULT 23s: OTHER INTERLOCKS ^{EA}	74
201	FAULT 23r: AUX INTERLOCK #5 ^{EA}	16
202	FAULT 23q: AUX INTERLOCK #4 ^{EA}	15
203	FAULT 23p: AIRFLOW SWITCH ^{EA}	13
204	FAULT 23o: LOW GAS PRESSURE ^{EA}	59
205	FAULT 23n: HIGH GAS PRESSURE ^{EA}	41
206	FAULT 23m: ATOMIZING SW ^{EA}	14
207	FAULT 23k: LOW OIL TEMP ^{EA}	62
208	FAULT 23j: HIGH OIL TEMP ^{EA}	44
209	FAULT 23i: LOW OIL PRESSURE ^{EA}	61
210	FAULT 23h: HIGH OIL PRESSURE ^{EA}	43
211	FAULT 23g: BOTH FUELS SELECT ^{EA}	21
212	FAULT 23f: FUEL SELECT OFF ^{EA}	38
213	FAULT 23e: AUX LIMIT #3 ^{EA}	19
214	FAULT 23d: HIGH LIMIT ^{EA}	42
215	FAULT 23c: LWCO ^{EA}	63

Table 22. 7800 SERIES Fault Codes. (Continued)

Fault Code (Reg 40001)	Fault Message (NOTE: FAULT n: is not in the Fault and Strings Code)	Fault String Code (Table 22)
216	FAULT 23b: AUX LIMIT #2 ^{EA}	18
217	FAULT 23a: AUX LIMIT #1 ^{EA}	17
218	FAULT 22s: OTHER INTERLOCKS ^{EA}	74
219	FAULT 22r: AUX INTERLOCK #5 ^{EA}	16
220	FAULT 22q: AUX INTERLOCK #4 ^{EA}	15
221	FAULT 22p: AIRFLOW SWITCH ^{EA}	13
222	FAULT 22o: LOW GAS PRESSURE ^{EA}	59
223	FAULT 22n: HIGH GAS PRESSURE ^{EA}	41
224	FAULT 22m: ATOMIZING SW ^{EA}	14
225	FAULT 22k: LOW OIL TEMP ^{EA}	62
226	FAULT 22j: HIGH OIL TEMP ^{EA}	44
227	FAULT 22i: LOW OIL PRESSURE ^{EA}	61
228	FAULT 22h: HIGH OIL PRESSURE ^{EA}	43
229	FAULT 22g: BOTH FUELS SELECT ^{EA}	21
230	FAULT 22f: FUEL SELECT OFF ^{EA}	38
231	FAULT 22e: AUX LIMIT #3 ^{EA}	19
232	FAULT 22d: HIGH LIMIT ^{EA}	42
233	FAULT 22c: LWCO ^{EA}	63
234	FAULT 22b: AUX LIMIT #2 ^{EA}	18
235	FAULT 22a: AUX LIMIT #1 ^{EA}	17
236	FAULT 21s: OTHER INTERLOCKS ^{EA}	74
237	FAULT 21r: AUX INTERLOCK #5 ^{EA}	16
238	FAULT 21q: AUX INTERLOCK #4 ^{EA}	15
239	FAULT 21p: AIRFLOW SWITCH ^{EA}	13
240	FAULT 21o: LOW GAS PRESSURE ^{EA}	59
241	FAULT 21n: HIGH GAS PRESSURE ^{EA}	41
242	FAULT 21m: ATOMIZING SW ^{EA}	14
243	FAULT 21k: LOW OIL TEMP ^{EA}	62

Table 22. 7800 SERIES Fault Codes. (Continued)

Fault Code (Reg 40001)	Fault Message (NOTE: FAULT n: is not in the Fault and Strings Code)	Fault String Code (Table 22)
244	FAULT 21j: HIGH OIL TEMP ^{EA}	44
245	FAULT 21i: LOW OIL PRESSURE ^{EA}	61
246	FAULT 21h: HIGH OIL PRESSURE ^{EA}	43
247	FAULT 21g: BOTH FUELS SELECT ^{EA}	21
248	FAULT 21f: FUEL SELECT OFF ^{EA}	38
249	FAULT 21e: AUX LIMIT #3 ^{EA}	19
250	FAULT 21d: HIGH LIMIT ^{EA}	42
251	FAULT 21c: LWCO ^{EA}	63
252	FAULT 21b: AUX LIMIT #2 ^{EA}	18
253	FAULT 21a: AUX LIMIT #1 ^{EA}	17
254	FAULT 10z: OTHER PREIGN ILK ^{EA}	75
255	FAULT 10y: VALVE CLOSURE ^{EA}	109

7800 SERIES Burner Control Fault History Records

Table 23 describes the registers that are part of a fault history record. To determine the actual register address for a parameter within the record, add the register offset to the start address of the record.

Table 23. Fault History Record Format.

Offset	Parameter Name	Access	Format	Notes
0	Fault code	R	U16	See Table 22.
1	Fault String	R	U16	See Table 22.
2	Sequence State	R	U16	See Table 20.
3	First line message	R	U16	See Table 15.
4	Second line message	R	U16	See Table 15.
5	Sequence time	R	U16	Seconds.
6-7	Total cycles	R	U32	
8-9	Total hours	R	U32	

Automation and Control Solutions

Honeywell International Inc.
1985 Douglas Drive North
Golden Valley, MN 55422
customer.honeywell.com

Honeywell Limited-Honeywell Limitée
35 Dynamic Drive
Scarborough, Ontario M1V 4Z9

® U.S. Registered Trademark
© 2006 Honeywell International Inc.
65-0090—6 M.S. Rev. 5-06



Printed in U.S.A. on recycled
paper containing at least 10%
post-consumer paper fibers.

Honeywell